

ENGLISH
2023/2024

ELECTRAPLAN



UNDERFLOOR SYSTEM



/CONTENTS

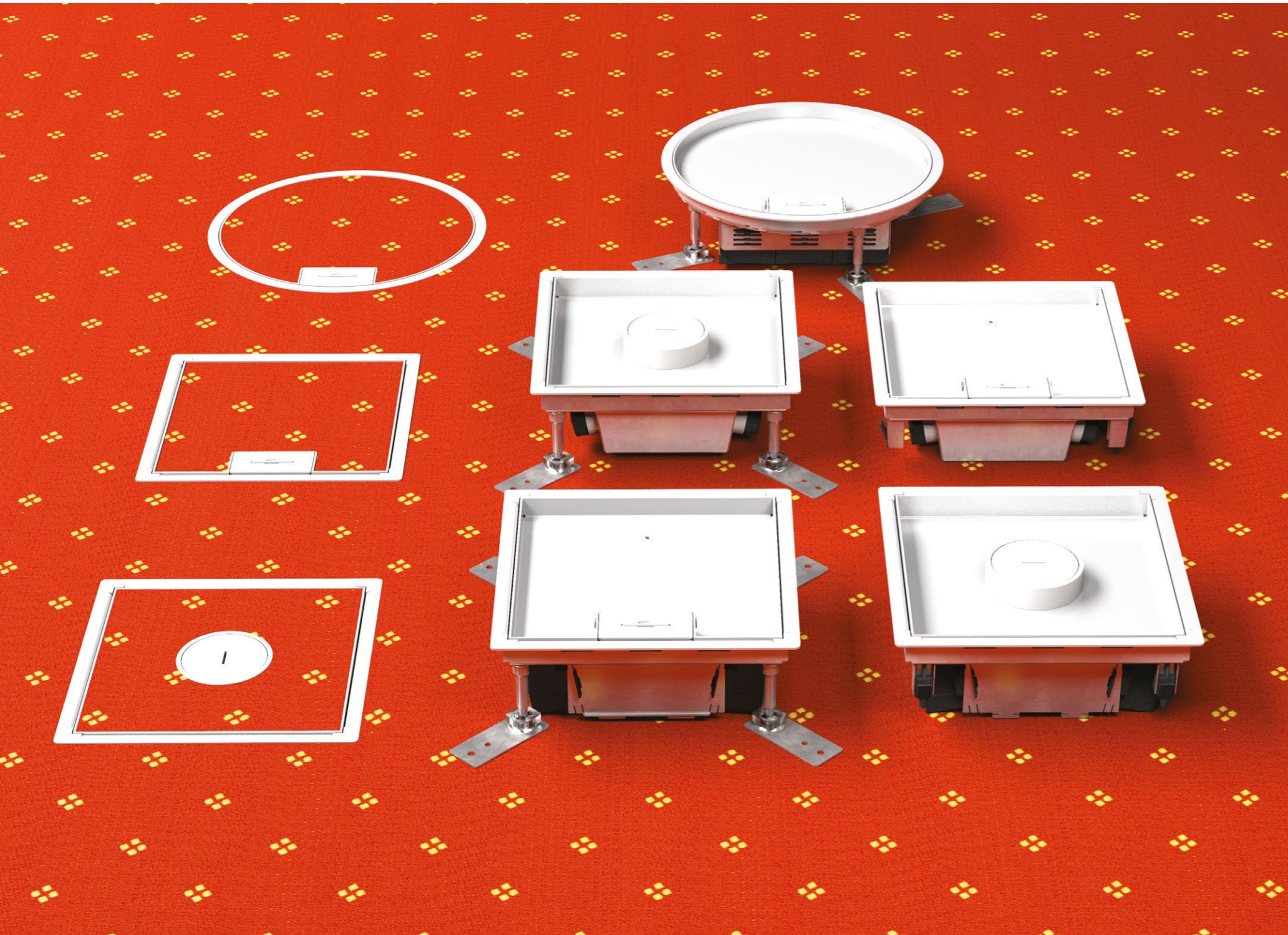

04	INTRODUCTION
08	UNDERFLOOR DUCTS
14	UNDERFLOOR BOXES
18	CASSETTES
22	MOUNTING LIDS
28	PLASTIC COVERS
36	CASSETTE COVERS
62	IP-PROTECTED CASSETTE COVERS
66	APPLIANCES AND ACCESSORIES
82	REFERENCES
86	CERTIFICATES

/INTRODUCTION



Érd headquarters



Vésztő site

Electraplan-Production Ltd. started its activity in 1994 in the field of trade and production of electrical installation materials. Since the beginning, we have expanded our range of products and services. Our main activity is metalworking, in which we apply customized solutions in the manufacture of our various products. In addition to our headquarters in Érd, we have manufacturing and production facilities in three counties (Vésztő, Nyírad, Óhíd). Our production is carried out with various stamping, welding and cutting machines, CNC laser cutting, pipe laser, profiling and edge bending machines. Our constantly expanding machine park allows us to meet growing and specific requirements. Our company's highly skilled technicians work with state-of-the-art design programs to develop existing and new products.



Nyírad site



Óhíd site



/PRODUCTION

Laser cutting / Bending

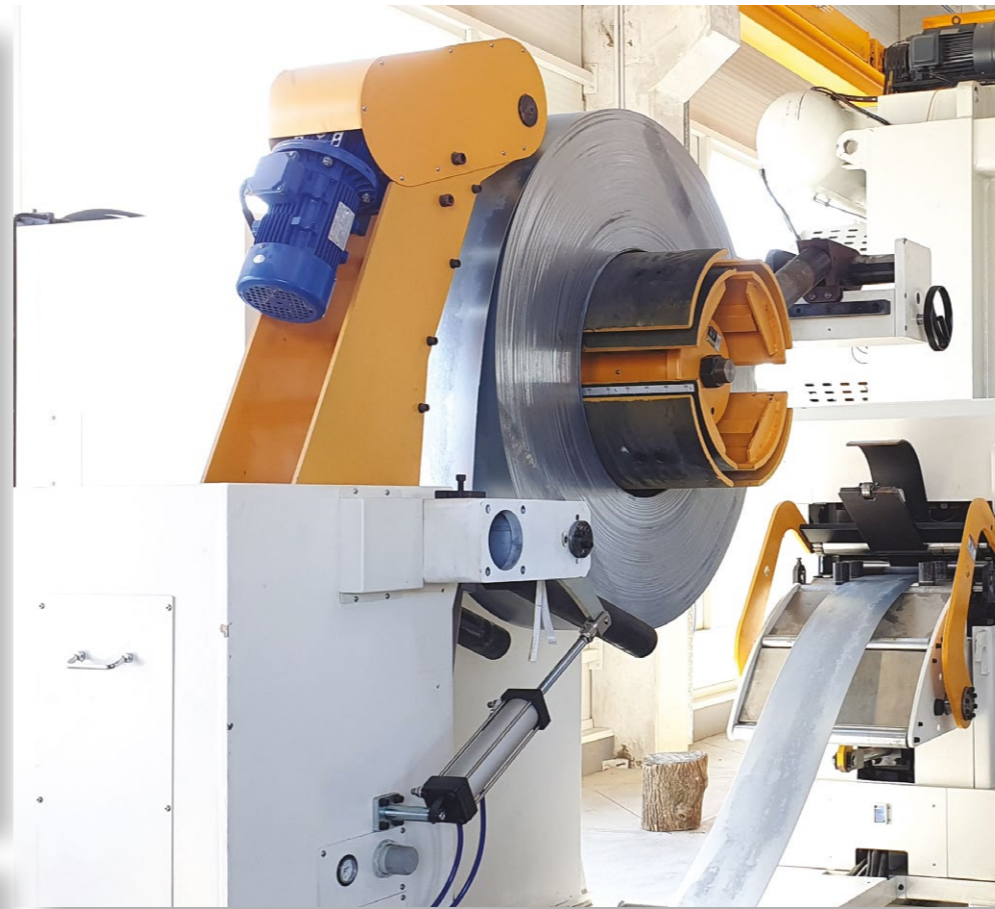

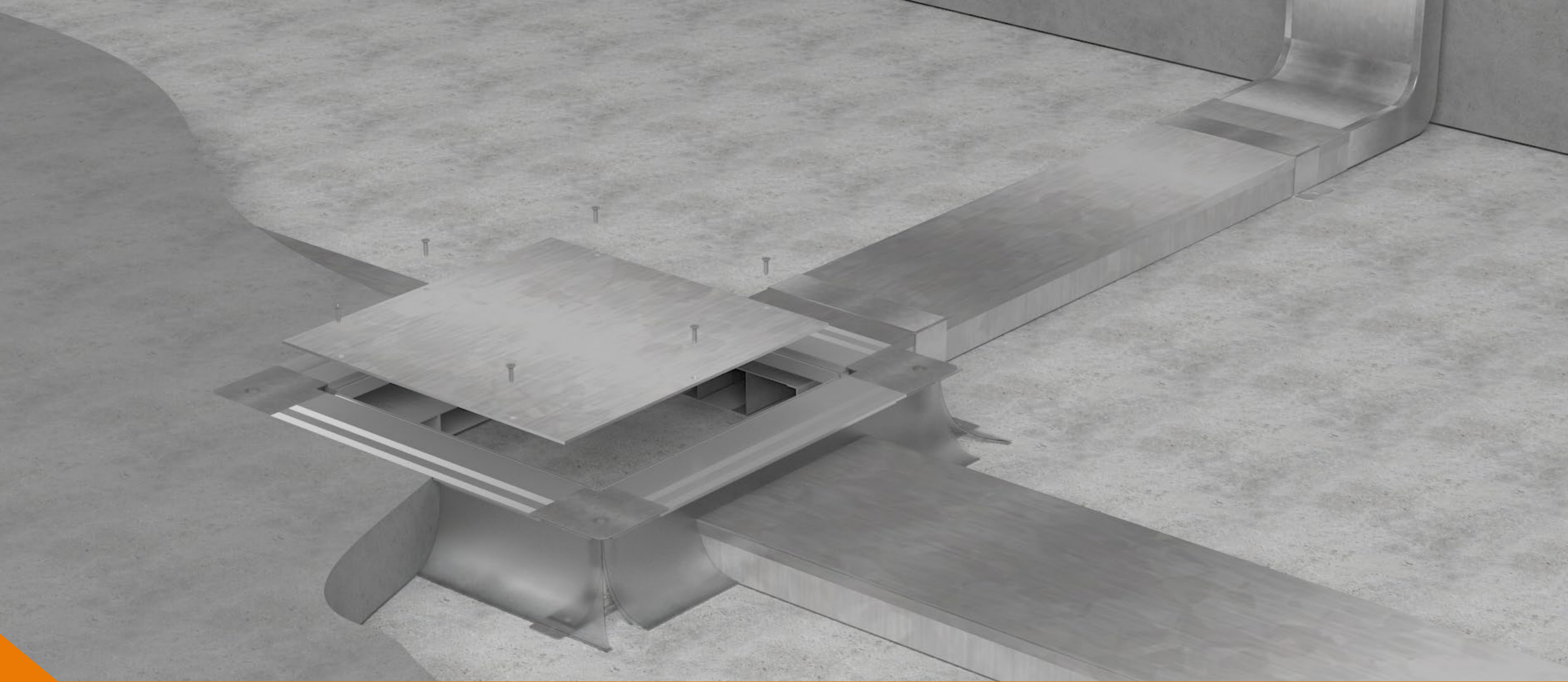

UNDERFLOOR DUCTS



/UNDERFLOOR DUCTS

Underfloor ducts	Ext. dim. (mm)			Vertical elbow	Fastening Clamp	Coupler	End blanks
	W.	L.	H.				
EUK 190...	190	2500	28	EUKK 190...	EUKB 190...	EUKS 190...	EUK 190...
			38				
			48				
EUK 240...	240	2500	28	EUKK 240...	EUKB 240...	EUKS 240...	EUK 240...
			38				
			48				
EUK 340...	340	2500	28	EUKK 340...	EUKB 340...	EUKS 340...	EUK 340...
			38				
			48				

IMPORTANT: The height of the screed above the duct must be at least 40 mm!

UNDERFLOOR DUCTS\

VERTICAL ELBOWS



EUKK ELBOW

Article	Ext. dim. (mm)			Compartments	PU. (pcs)	Wgt. (kg)	EAN	Order number
	W.	L.	H.					
EUKK 190.28-2	190	200	28	2 comp.	1	1,1	77127 33	950EUKK 190 28 2
EUKK 190.38-2	190	200	38	2 comp.	1	1,15	77127 40	950EUKK 190 38 2
EUKK 190.48-2	190	200	48	2 comp.	1	1,2	77127 57	950EUKK 190 48 2
EUKK 190.28-3	190	200	28	3 comp.	1	1,2	77127 64	950EUKK 190 28 3
EUKK 190.38-3	190	200	38	3 comp.	1	1,25	77127 71	950EUKK 190 38 3
EUKK 190.48-3	190	200	48	3 comp.	1	1,3	77127 88	950EUKK 190 48 3
EUKK 240.28-2	240	200	28	2 comp.	1	1,3	77127 95	950EUKK 240 28 2
EUKK 240.38-2	240	200	38	2 comp.	1	1,35	77128 01	950EUKK 240 38 2
EUKK 240.48-2	240	200	48	2 comp.	1	1,4	77128 18	950EUKK 240 48 2
EUKK 240.28-3	240	200	28	3 comp.	1	1,4	77128 25	950EUKK 240 28 3
EUKK 240.38-3	240	200	38	3 comp.	1	1,45	77128 32	950EUKK 240 38 3
EUKK 240.48-3	240	200	48	3 comp.	1	1,5	77128 49	950EUKK 240 48 3
EUKK 340.28-2	340	200	28	2 comp.	1	1,7	77128 56	950EUKK 340 28 2
EUKK 340.38-2	340	200	38	2 comp.	1	1,75	77128 63	950EUKK 340 38 2
EUKK 340.48-2	340	200	48	2 comp.	1	1,8	77128 70	950EUKK 340 48 2
EUKK 340.28-3	340	200	28	3 comp.	1	1,8	77128 87	950EUKK 340 28 3
EUKK 340.38-3	340	200	38	3 comp.	1	1,85	77128 94	950EUKK 340 38 3
EUKK 340.48-3	340	200	48	3 comp.	1	1,9	77129 00	950EUKK 340 48 3

For vertical direction changes of underfloor ducts, for routing cables. Top plate radius: 40 mm.

UNDERFLOOR DUCTS

EUK underfloor duct



Article	Ext. dim. (mm)			Compartments	PU. (m)	Wgt. (kg)	EAN	Order number
	W.	L.	H.					
EUK 190.28-2	190	2500	28	2 comp.	2,5	7,8	77125 59	950EUK 190 28 2
EUK 190.38-2	190	2500	38	2 comp.	2,5	8,2	77125 66	950EUK 190 38 2
EUK 190.48-2	190	2500	48	2 comp.	2,5	8,6	77125 73	950EUK 190 48 2
EUK 190.28-3	190	2500	28	3 comp.	2,5	8,6	77125 80	950EUK 190 28 3
EUK 190.38-3	190	2500	38	3 comp.	2,5	9	77125 97	950EUK 190 38 3
EUK 190.48-3	190	2500	48	3 comp.	2,5	9,6	77126 03	950EUK 190 48 3
EUK 240.28-2	240	2500	28	2 comp.	2,5	9,2	77126 10	950EUK 240 28 2
EUK 240.38-2	240	2500	38	2 comp.	2,5	9,6	77126 27	950EUK 240 38 2
EUK 240.48-2	240	2500	48	2 comp.	2,5	10	77126 34	950EUK 240 48 2
EUK 240.28-3	240	2500	28	3 comp.	2,5	9,8	77126 41	950EUK 240 28 3
EUK 240.38-3	240	2500	38	3 comp.	2,5	10,4	77126 58	950EUK 240 38 3
EUK 240.48-3	240	2500	48	3 comp.	2,5	11	77126 65	950EUK 240 48 3
EUK 340.28-2	340	2500	28	2 comp.	2,5	12,2	77126 72	950EUK 340 28 2
EUK 340.38-2	340	2500	38	2 comp.	2,5	12,6	77126 89	950EUK 340 38 2
EUK 340.48-2	340	2500	48	2 comp.	2,5	13	77126 96	950EUK 340 48 2
EUK 340.28-3	340	2500	28	3 comp.	2,5	12,8	77127 02	950EUK 340 28 3
EUK 340.38-3	340	2500	38	3 comp.	2,5	13,4	77127 19	950EUK 340 38 3
EUK 340.48-3	340	2500	48	3 comp.	2,5	14	77127 26	950EUK 340 48 3

Underfloor duct for routing cables under the screed.

ACCESSORIES



EUKB FASTENING CLAMP

Article	Ext. dim. (mm)			Thickness (mm)	PU. (pcs)	Wgt. (kg)	EAN	Order number
	W.	L.	H.					
EUKB 190.28	190	50	28	1	1	0,11	77129 17	950EUKB 190 28
EUKB 190.38	190	50	38	1	1	0,12	77129 24	950EUKB 190 38
EUKB 190.48	190	50	48	1	1	0,13	77129 31	950EUKB 190 48
EUKB 240.28	240	50	28	1	1	0,13	77129 48	950EUKB 240 28
EUKB 240.38	240	50	38	1	1	0,14	77129 55	950EUKB 240 38
EUKB 240.48	240	50	48	1	1	0,15	77129 62	950EUKB 240 48
EUKB 340.28	340	50	28	1	1	0,18	77129 79	950EUKB 340 28
EUKB 340.38	340	50	38	1	1	0,19	77129 86	950EUKB 340 38
EUKB 340.48	340	50	48	1	1	0,2	77129 93	950EUKB 340 48

To fix underfloor ducts to the ground.



EUKS COUPLER

Article	Ext. dim. (mm)			Thickness (mm)	PU. (pcs)	Wgt. (kg)	EAN	Order number
	W.	L.	H.					
EUKS 190.28	190	50	28	1	1	0,21	77130 06	950EUKS 190 28
EUKS 190.38	190	50	38	1	1	0,22	77130 13	950EUKS 190 38
EUKS 190.48	190	50	48	1	1	0,23	77130 20	950EUKS 190 48
EUKS 240.28	240	50	28	1	1	0,25	77130 37	950EUKS 240 28
EUKS 240.38	240	50	38	1	1	0,26	77130 44	950EUKS 240 38
EUKS 240.48	240	50	48	1	1	0,27	77130 51	950EUKS 240 48
EUKS 340.28	340	50	28	1	1	0,33	77130 68	950EUKS 340 28
EUKS 340.38	340	50	38	1	1	0,34	77130 75	950EUKS 340 38
EUKS 340.48	340	50	48	1	1	0,35	77130 82	950EUKS 340 48

To connect underfloor ducts.



EUKE END BLANKS

Article	Ext. dim. (mm)			Thickness (mm)	PU. (pcs)	Wgt. (kg)	EAN	Order number
	W.	L.	H.					
EUKE 190.28	190	20	28	1	1	0,1	77130 99	950EUKE 190 28
EUKE 190.38	190	20	38	1	1	0,11	77131 05	950EUKE 190 38
EUKE 190.48	190	20	48	1	1	0,12	77131 12	950EUKE 190 48
EUKE 240.28	240	20	28	1	1	0,12	77131 29	950EUKE 240 28
EUKE 240.38	240	20	38	1	1	0,13	77131 36	950EUKE 240 38
EUKE 240.48	240	20	48	1	1	0,14	77131 43	950EUKE 240 48
EUKE 340.28	340	20	28	1	1	0,18	77131 50	950EUKE 340 28
EUKE 340.38	340	20	38	1	1	0,19	77131 67	950EUKE 340 38
EUKE 340.48	340	20	48	1	1	0,2	77131 74	950EUKE 340 48

To close the end of the underfloor ducts.

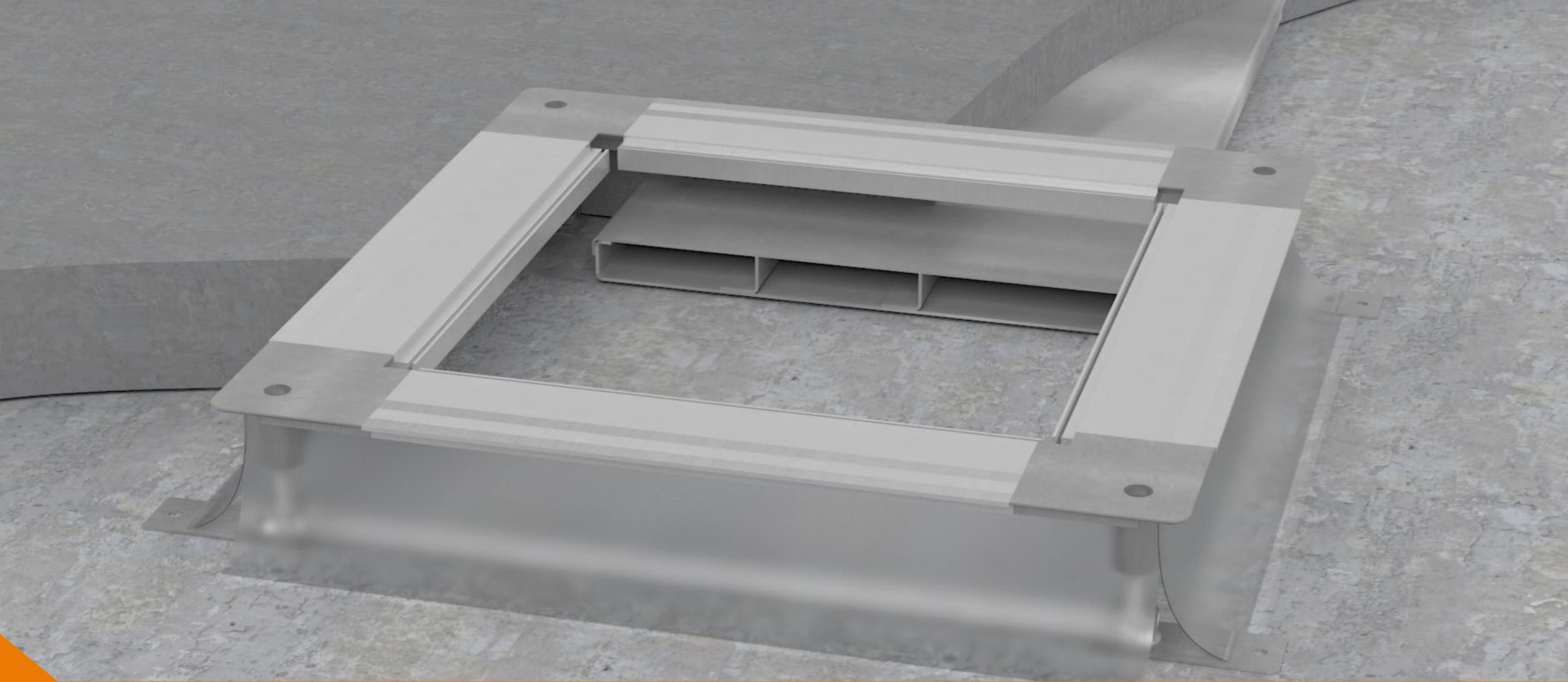

UNDERFLOOR BOXES



/UNDERFLOOR BOXES

	Underfloor boxes	Ext. dim. (mm)			Int. dim. (mm)		Cassettes	Mounting lids	Cassette covers
		W.	L.	H.	W.	L.			
Universal underfloor boxes	UDH 2	426	426	50-110	290	290	UFKK Q2...	UDM2...	ECO, F, V
				120-170					
Universal underfloor boxes	UDH 3	497	497	50-110	360	360	UFKK Q3...	UDM3...	C, ECO, F, V
				120-170					
Direct underfloor boxes	UDH E2	384	283	50-110	245	146	-	-	KD1 E2...
				120-170					
	UDH E4	384	427	50-110	244	287	-	-	KD1 E4...
				120-170					
UDH Q2	365	365	50-110	224	224	-	-	KD1 Q2..., KD1 Q12...	
			120-170						
UDH ECO250	393	393	50-110	252	252	-	-	ECO	

UNIVERSAL UNDERFLOOR BOXES

UDH 2



Article	Ext. dim. (mm)			Int. dim. (mm)		PU. (pcs)	Wgt. (kg)	EAN	Order number
	W.	L.	H.	W.	L.				
UDH 2 50-110	426	426	50-110	290	290	1	3,03	21047 29	9502520508201
UDH 2 120-170	426	426	120-170	290	290	1	3,54	21047 36	9502521208201

For ECO-, F-, and V-series cassette covers and for plastic covers with UDM2 mounting lids, and for UFKK Q2 cassettes.
With different levelling ranges.

UDH 3



Article	Ext. dim. (mm)			Int. dim. (mm)		PU. (pcs)	Wgt. (kg)	EAN	Order number
	W.	L.	H.	W.	L.				
UDH 3 50-110	497	497	50-110	360	360	1	4	21047 67	9502530508201
UDH 3 120-170	497	497	120-170	360	360	1	4	21048 04	9502531208201

For C-, ECO-, F-, and V-series cassette covers and for plastic covers with UDM3 mounting lids, and for UFKK Q3 cassettes.
With different levelling ranges.

UNDERFLOOR BOXES\

DIRECT UNDERFLOOR BOXES



UDH E2

Article	Ext. dim. (mm)			Int. dim. (mm)		PU. (pcs)	Wgt. (kg)	EAN	Order number
	W.	L.	H.	W.	L.				
UDH E2 50-110	384	283	50-110	245	146	1	2,2	77020 24	9542503148201

For KD1 E2 plastic covers.

UDH E4



Article	Ext. dim. (mm)			Int. dim. (mm)		PU. (pcs)	Wgt. (kg)	EAN	Order number
	W.	L.	H.	W.	L.				
UDH E4 50-110	384	427	50-110	244	287	1	2,2	77039 91	9542513148201

For KD1 E4 plastic covers.

UDH Q2



Article	Ext. dim. (mm)			Int. dim. (mm)		PU. (pcs)	Wgt. (kg)	EAN	Order number
	W.	L.	H.	W.	L.				
UDH Q2 50-110	365	365	50-110	224	224	1	2,9	77019 80	9542553148201
UDH Q2 120-170	365	365	120-170	224	224	1	2,9	77074 18	9542553149201

For KD1 Q2 and KD1 Q12 plastic covers.
With different levelling ranges.

UDH ECO250



Article	Ext. dim. (mm)			Int. dim. (mm)		PU. (pcs)	Wgt. (kg)	EAN	Order number
	W.	L.	H.	W.	L.				
UDH ECO250 50-110	393	393	50-110	252	252	1	3,1	77131 98	950UDH252x25250110

For ECO250 cassette covers.

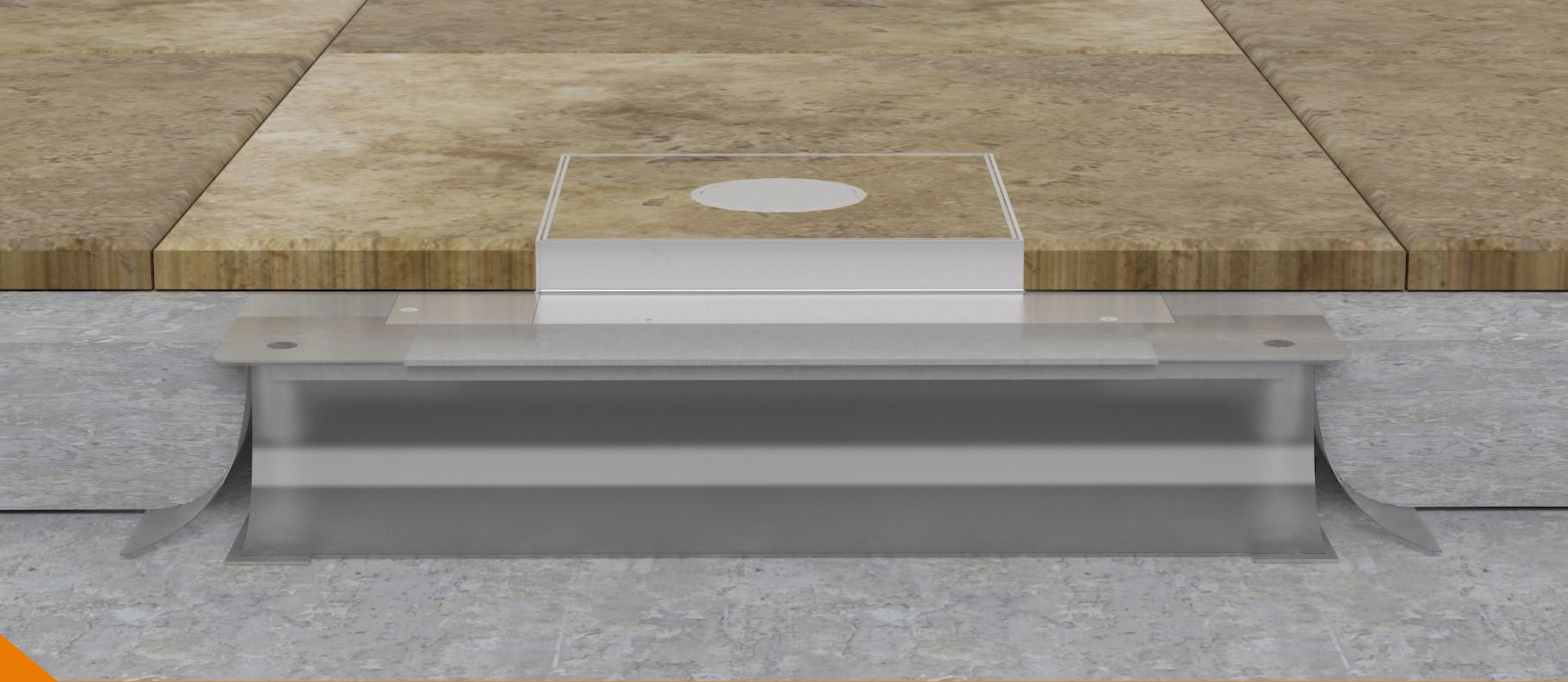

CASSETTES



/CASSETTES

CASSETTES\

Cassettes	Dimensions (mm)		Depth of floor recess (mm)	Cover type	Underfloor box
	W.	L.			
UFKK Q2 BL	250	250	20	blind cover inspecton	UDH 2
UFKK Q2 LE	250	250	20	cable outlet	UDH 2
UFKK Q2 TUM	250	250	23	tube cable outlet	UDH 2
UFKK Q3 BL	250	250	20	blind cover inspecton	UDH 3
UFKK Q3 LE	250	250	20	cable outlet	UDH 3
UFKK Q3 TUM	250	250	23	tube cable outlet	UDH 3

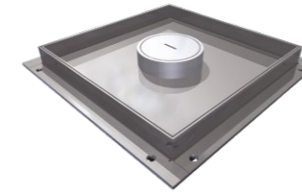

UFKK Q2 TUM

Article	Ext. dim. (mm)		Floor covering thickness (mm)	PU. (pcs)	Wgt. (kg)	EAN	Order number
	W.	L.					
UFKK Q2 TUM E20	250	250	23	1	3,11	77124 29	950UFKK Q2TUM E20

For UDH 2 underfloor boxes.
Cassette with tube cable outlet.
For 12 pcs. appliances with 3 pcs GB3 569 8M apparatus boxes.

CASSETTES FOR UDH 3 UNDERFLOOR BOXES:

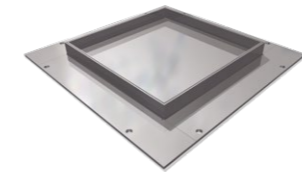

UFKK Q3 BL

Article	Ext. dim. (mm)		Floor covering thickness (mm)	PU. (pcs)	Wgt. (kg)	EAN	Order number
	W.	L.					
UFKK Q3 BL E20	250	250	20	1	3,96	77124 36	950UFKK Q3BL E20

For UDH 3 underfloor boxes.
Blind cassette.

CASSETTES FOR UDH 2 UNDERFLOOR BOXES:

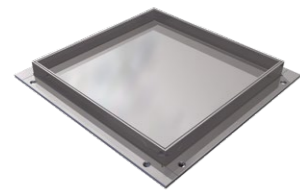

UFKK Q2 BL

Article	Ext. dim. (mm)		Floor covering thickness (mm)	PU. (pcs)	Wgt. (kg)	EAN	Order number
	W.	L.					
UFKK Q2 BL E20	250	250	20	1	2,58	77124 05	950UFKK Q2BL E20

For UDH 2 underfloor boxes.
Blind cassette.



UFKK Q2 LE

Article	Ext. dim. (mm)		Floor covering thickness (mm)	PU. (pcs)	Wgt. (kg)	EAN	Order number
	W.	L.					
UFKK Q2 LE E20	250	250	20	1	2,93	77124 12	950UFKK Q2LE E20

For UDH 2 underfloor boxes.
Cassette with cable outlet.
For 12 pcs. appliances with 3 pcs GB3 569 8M apparatus boxes.

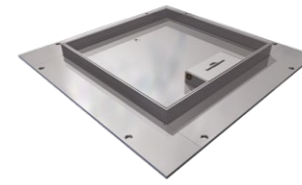

UFKK Q3 LE

Article	Ext. dim. (mm)		Floor covering thickness (mm)	PU. (pcs)	Wgt. (kg)	EAN	Order number
	W.	L.					
UFKK Q3 LE E20	250	250	20	1	4,42	77124 43	950UFKK Q3LE E20

For UDH 3 underfloor boxes.
Cassette with cable outlet.
For 12 pcs. appliances with 3 pcs GB3 569 8M apparatus boxes.

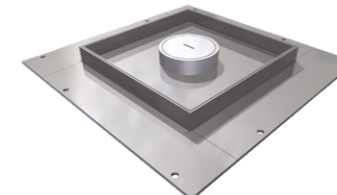

UFKK Q3 TUM

Article	Ext. dim. (mm)		Floor covering thickness (mm)	PU. (pcs)	Wgt. (kg)	EAN	Order number
	W.	L.					
UFKK Q3 TUM E20	250	250	23	1	5,56	77124 50	950UFKK Q3TUM E20

For UDH 3 underfloor boxes.
Cassette with tube cable outlet.
For 12 pcs. appliances with 3 pcs GB3 569 8M apparatus boxes.

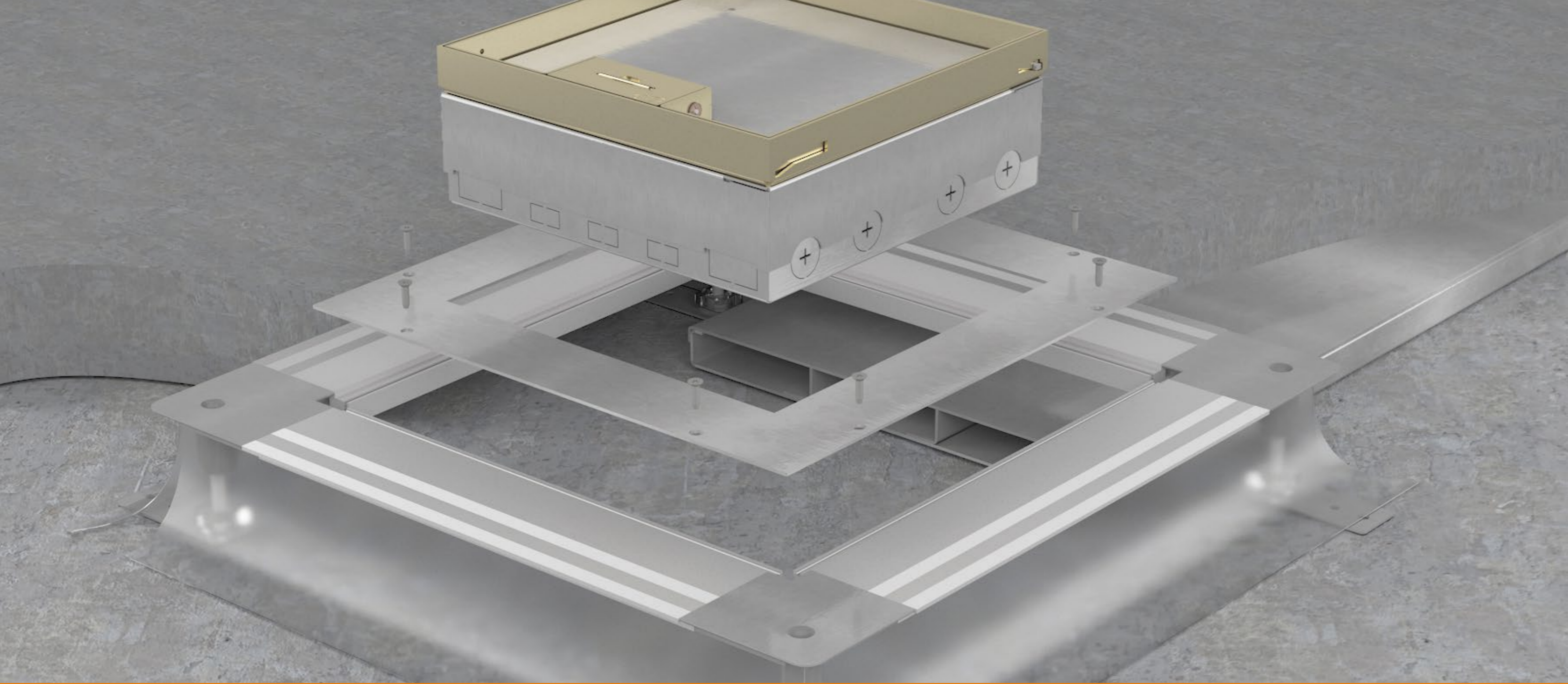

MOUNTING LIDS



/MOUNTING LIDS

Mounting lids	Cassette cover/plastic cover	Underfloor box	Mounting lids	Cassette cover	Underfloor box
UDM2 BL	-	UDH 2	UDM3 BL	-	UDH 3
UDM2 E2	KD1 E245	UDH 2	UDM3 Ø305	C-series	UDH 3
UDM2 Q2	KD1 Q2S, KD1 Q12S	UDH 2	UDM3 E2	KD1 E245	UDH 3
UDM2 250×250	ECO-series	UDH 2	UDM3 E4	KD1 E4S	UDH 3
			UDM3 Q2	KD1 Q2S, KD1 Q12S	UDH 3
			UDM3 250×250	ECO-series	UDH 3

MOUNTING LIDS FOR UDH 2 UNDERFLOOR BOXES:

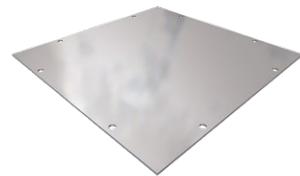

UDM2 BL

Article	Ext. dim. (mm)		Underfloor box	PU. (pcs)	Wgt. (kg)	EAN	Order number
	W.	L.					
UDM2 BL	290	290	UDH 2	1	2,68	20155 99	9502529206103

For UDH 2 underfloor boxes.
Blind mounting lid.

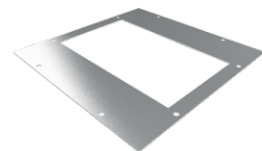

UDM2 E2

Article	Int. dim. (mm)		Underfloor box	PU. (pcs)	Wgt. (kg)	EAN	Order number
	W.	L.					
UDM2 E2	248	148	UDH 2	1	0,75	20156 05	9502529226103

For UDH 2 underfloor boxes.
For KD1 E245 plastic covers.

MOUNTING LIDS\

UDM2 Q2

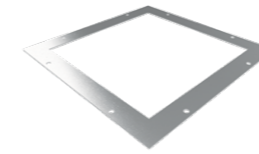

Article	Int. dim. (mm)		Underfloor box	PU. (pcs)	Wgt. (kg)	EAN	Order number
	W.	L.					
UDM2 Q2	231	231	UDH 2	1	0,49	20156 29	9502529246103

For UDH 2 underfloor boxes.
For KD1 Q2S and KD1 Q12S plastic covers.

UDM2 250×250



Article	Int. dim. (mm)		Underfloor box	PU. (pcs)	Wgt. (kg)	EAN	Order number
	W.	L.					
UDM2 250×250	251	251	UDH 2	1	0,32	77121 08 950UDM2250X250EM01	

For UDH 2 underfloor boxes.
For ECO-series cassette covers.

MOUNTING LIDS FOR UDH 3 UNDERFLOOR BOXES:

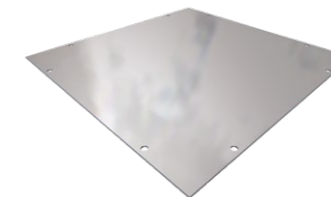

UDM3 BL

Article	Ext. dim. (mm)		Underfloor box	PU. (pcs)	Wgt. (kg)	EAN	Order number
	W.	L.					
UDM3 BL	360	360	UDH 3	1	4,16	20158 34	9502539206103

For UDH 3 underfloor boxes.
Blind mounting lid.

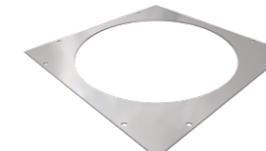

UDM3 Ø305

Article	Int. dim. (mm)		Underfloor box	PU. (pcs)	Wgt. (kg)	EAN	Order number
	W.	L.					
UDM3 Ø305	Ø307		UDH 3	1	0,86	77121 77 950UDM33050000EM01	

For UDH 3 underfloor boxes.
For C-series cassette covers.

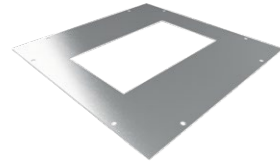

UDM3 E2

Article	Int. dim. (mm)		Underfloor box	PU. (pcs)	Wgt. (kg)	EAN	Order number
	W.	L.					
UDM3 E2	248	148	UDH 3	1	1,46	77132 04	9502539226103

For UDH 3 underfloor boxes.
For KD1 E245 plastic covers.

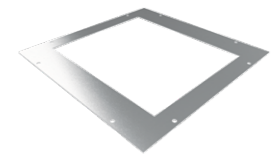

UDM3 E4

Article	Int. dim. (mm)		Underfloor box	PU. (pcs)	Wgt. (kg)	EAN	Order number
	W.	L.					
UDM3 E4	248	298	UDH 3	1	0,91	77132 11	9502539286103

For UDH 3 underfloor boxes.
For KD1 E4S plastic covers.

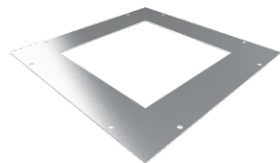

UDM3 Q2

Article	Int. dim. (mm)		Underfloor box	PU. (pcs)	Wgt. (kg)	EAN	Order number
	W.	L.					
UDM3 Q2	231	231	UDH 3	1	1,2	77132 28	9502539246103

For UDH 3 underfloor boxes.
For KD1 Q2S and KD1 Q12S plastic covers.



UDM3 250x250

Article	Int. dim. (mm)		Underfloor box	PU. (pcs)	Wgt. (kg)	EAN	Order number
	W.	L.					
UDM3 250x250	251	251	UDH 3	1	0,32	77121 53	950UDM3250X250EM01

For UDH 3 underfloor boxes.
For ECO-series cassette covers.



**PLASTIC
COVERS**

Plastic covers

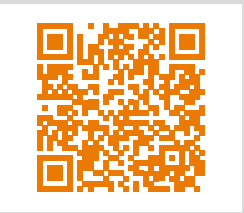
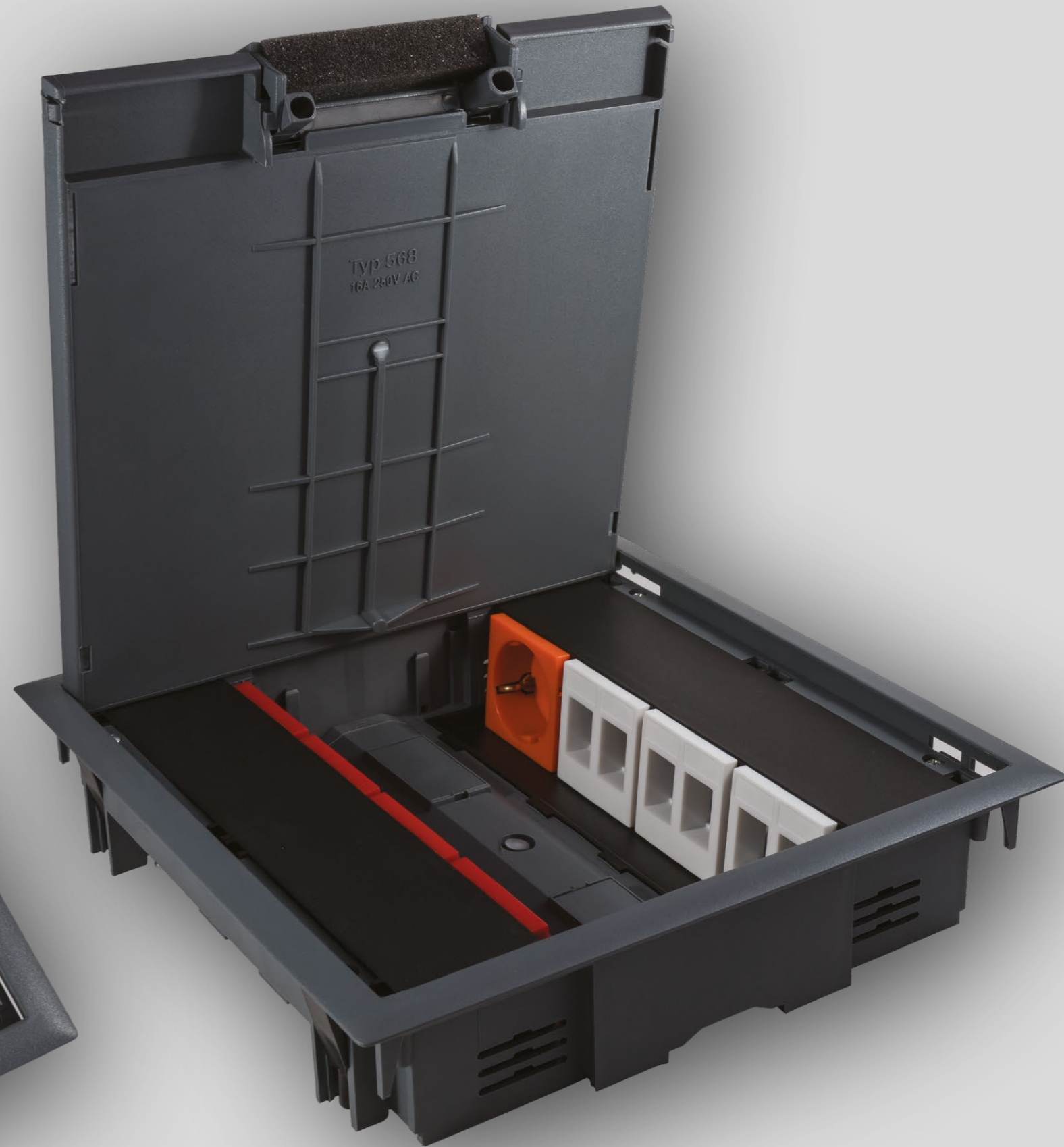

in several colours, for screed and cavity floor, for standard office load



/PLASTIC COVERS

Plastic covers	Int. dim. (mm)			Min. installation depth	Floor covering thickness (mm)	Number of appliances		Apparatus box	
	W.	L.	H.			pcs	type	pcs	type
KD1 E245 R5	247	147	55	55	5	4	MOSAIC 45	2	GB4 M4/45
KD1 E245 K12	247	147	55	55	12	4	MOSAIC 45	2	GB4 M4/45
KD1 Q2S R5	230	230	55	55	5	8	MOSAIC 45	2	GB4 M8/45
KD3 Q2S R5	230	230	55	55	5	8	MOSAIC 45	2	GB4 M8/45
KD1 Q2S K12	230	230	55	55	12	8	MOSAIC 45	2	GB4 M8/45
KD1 E4S R5	247	291	55	55	5	10	MOSAIC 45	2-2	GB4 M4/45 and GB4 M6/45
KD1 E4S K12	247	291	55	55	12	10	MOSAIC 45	2-2	GB4 M4/45 and GB4 M6/45
KD3 E4S R5	247	291	55	55	5	10	MOSAIC 45	2-2	GB4 M4/45 and GB4 M6/45
KD3 Q12S R5	230	230	70	70	5	12	MOSAIC 45	3	GB3 569 8M
KDR1 R3R5	Ø305	55	70	5	12	MOSAIC 45	3	GB3 569 8M	
KDR3 R3R5	Ø305	55	70	5	12	MOSAIC 45	3	GB3 569 8M	

Available colours:

-  RAL 1019 - grey beige
-  RAL 7011 - iron grey
-  RAL 9005 - jet black

Floor type	Flooring type	Frame	Underfloor box	Mounting lid for universal underfloor box	
				UDH 2	UDH 3
Cavity floor, screed*	Carpeting, PVC	yes	UDH E2	UDM2 E2	UDM3 E2
Concrete*	Tiles, wood floor	no	UDH E2	UDM2 E2	UDM3 E2
Concrete*	Carpeting, PVC	yes	UDH Q2	UDM2 Q2	UDM3 Q2
Cavity floor	Carpeting, PVC	yes	-	-	-
Concrete*	Tiles, wood floor	no	UDH Q2	UDM2 Q2	UDM3 Q2
Concrete*	Carpeting, PVC	yes	UDH E4	-	UDM3 E4
Concrete*	Tiles, wood floor	no	UDH E4	-	UDM3 E4
Cavity floor	Carpeting, PVC	yes	-	-	-
Cavity floor	Carpeting, PVC	yes	-	-	-
Cavity floor, screed*	Carpeting, PVC	yes	UDH 3	-	UDM3 Ø305
Cavity floor	Carpeting, PVC	yes	UDH 3	-	UDM3 Ø305

*Underfloor box is required for mounting in screed. See page 16.



KD1 E245

Article	Dimensions (mm)			Floor covering thickness (mm)	Appliances Nr. (pcs)	PU. (pcs)	Wgt. (kg)	Order number*
	W.	L.	H.					
KD1 E245 R5	247	147	55	5	4	1	1,25	950KD1E245R5 [RAL]*
KD1 E245 K12	247	147	55	12	4	1	1,25	950KD1E245K12 [RAL]*

Plastic cover for cavity floor, 247×147 mm, for 4 appliances.

With floor covering protection frame.

For 2 pcs. of GB4 M4/45 apparatus boxes, for 4 pcs. of MOSAIC 45 appliances.

Mounting in screed is possible with UDH E2 underfloor box, or using UDM2 E2 mounting lid with UDH 2 underfloor box, or using UDM3 E2 mounting lid with UDH 3 underfloor box.

Available colours: ● ● ●



KD1 Q2S

Article	Dimensions (mm)			Floor covering thickness (mm)	Appliances Nr. (pcs)	PU. (pcs)	Wgt. (kg)	Order number*
	W.	L.	H.					
KD1 Q2S R5	230	230	55	5	8	1	1,49	950KD1Q2SR5 [RAL]*
KD1 Q2S K12	230	230	55	12	8	1	1,49	950KD1Q2SK12 [RAL]*
KD3 Q2S R5	230	230	55	5	8	1	1,49	950KD3Q2SR5 [RAL]*

KD3: Plastic cover for cavity floor, 230×230 mm, for 8 appliances.

With floor covering protection frame.

For 2 pcs. of GB4 M8/45 apparatus boxes, for 8 pcs. of MOSAIC 45 appliances.

KD1: Mounting in screed is possible with UDH Q2 underfloor box, or using UDM2 Q2S mounting lid with UDH 2 underfloor box, or using UDM3 Q2S mounting lid with UDH 3 underfloor box.

Available colours: ● ● ●



KD1 E4S

Article	Dimensions (mm)			Floor covering thickness (mm)	Appliances Nr. (pcs)	PU. (pcs)	Wgt. (kg)	Order number*
	W.	L.	H.					
KD1 E4S R5	247	291	55	5	10	1	1,25	950KD1E4SR5 [RAL]*
KD1 E4S K12	247	291	55	12	10	1	1,25	950KD1E4SK12 [RAL]*
KD1 E4S R5	247	291	55	5	10	1	1,25	950KD3E4SR5 [RAL]*

KD3: Plastic cover for cavity floor, 247×291 mm, for 10 appliances.

With floor covering protection frame.

For 2 pcs. of GB4 M4/45 and 2 pcs. of GB4 M6/45 apparatus boxes, for 10 pcs. of MOSAIC 45 appliances.

KD1: Mounting in screed is possible with UDH E4 underfloor box, or using UDM3 E4S mounting lid with UDH 3 underfloor box.

Available colours: ● ● ●



KD3 Q12S

Article	Dimensions (mm)			Floor covering thickness (mm)	Appliances Nr. (pcs)	PU. (pcs)	Wgt. (kg)	Order number*
	W.	L.	H.					
KD1 Q12S R5	230	230	55	5	12	1	2,99	950KD1Q12SR5-12 [RAL]*
KD1 Q12S R12	230	230	55	12	12	1	2,99	950KD1Q12SR12-12 [RAL]*
KD3 Q12S R5	230	230	55	5	12	1	2,99	950KD3Q12SR5-12 [RAL]*
KD3 Q12S R12	230	230	55	12	12	1	2,99	950KD3Q12SR12-12 [RAL]*

KD3: Plastic cover for cavity floor, 230×230 mm, for 12 appliances.

With floor covering protection frame.

For 3 pcs. of GB3 569 8M apparatus boxes, for 12 pcs. of MOSAIC 45 appliances.

Primarily for carpeting or PVC.

KD1: Mounting in screed is possible with UDH Q2 underfloor box, or using UDM2 Q12S mounting lid with UDH 2 underfloor box, or using UDM3 Q12S mounting lid with UDH 3 underfloor box.

Available colours: ● ● ●

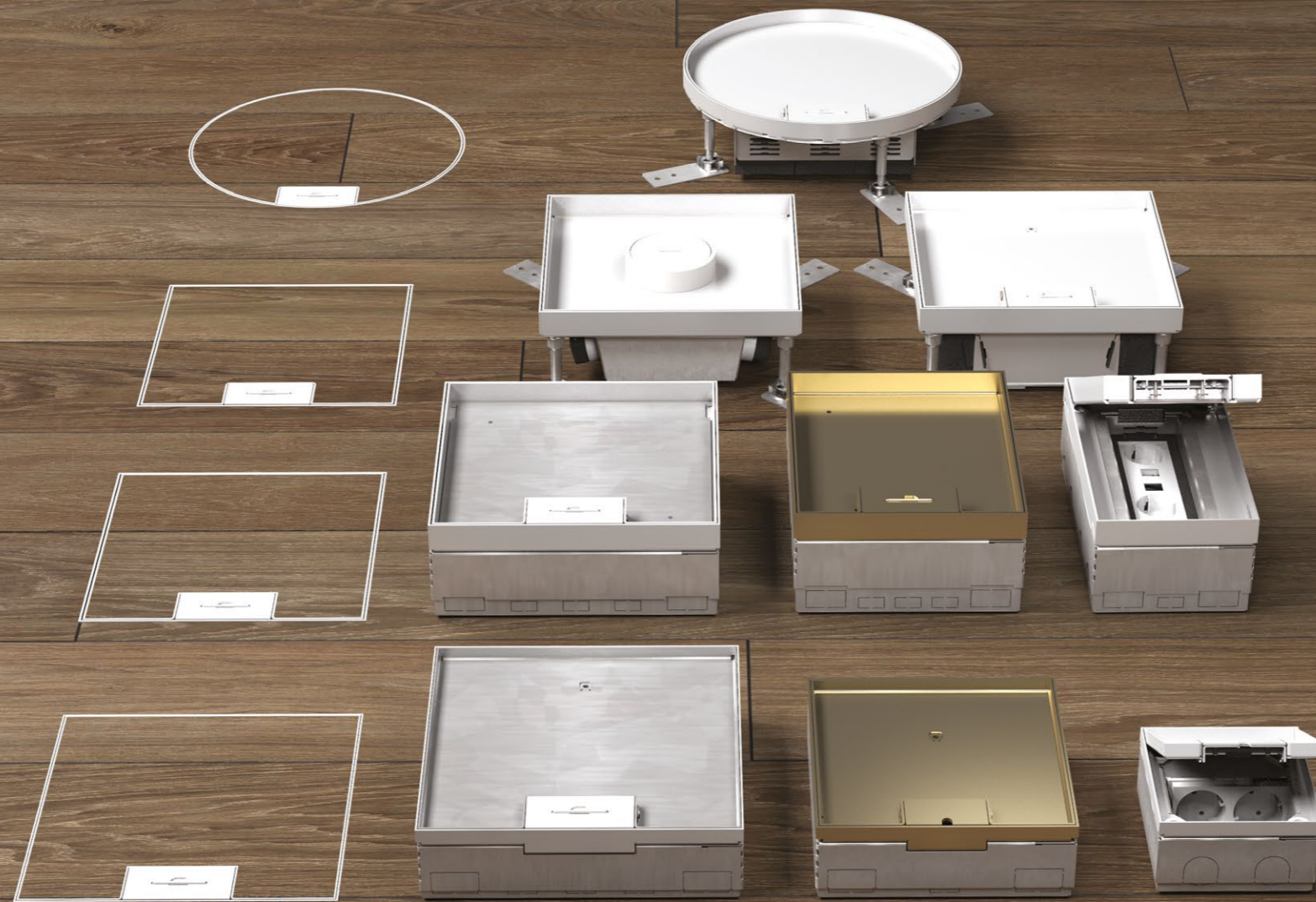

CASSETTE COVERS

/CASSETTE COVERS

The cassette covers offer solutions for electrical installation in the floor. A wide range of appliances gives the user access to power, data and multimedia connections. The compact, floor-flush cassettes can be adjusted to the height of the floor. Cassettes are particularly suitable for floor coverings such as tiles or parquet. There are various versions for dry and wet-cleaned floor coverings. Stainless steel and brass not only look good, they also provide lasting quality.



IN CAVITY FLOOR

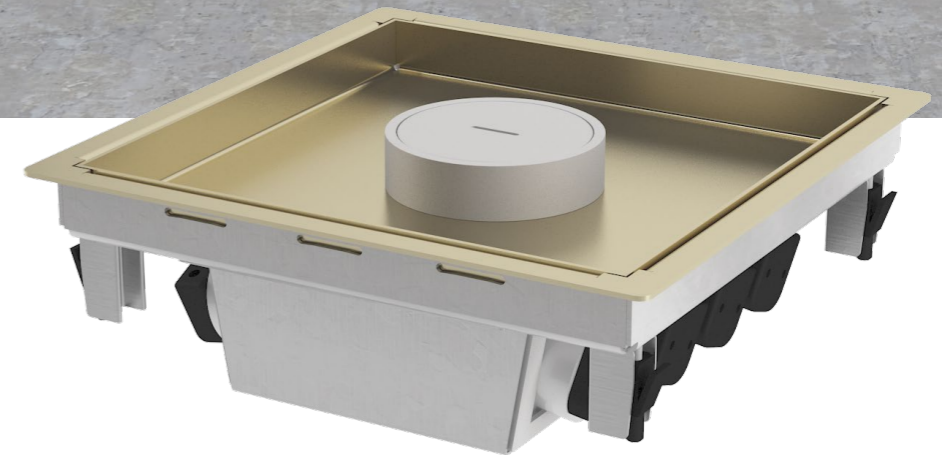
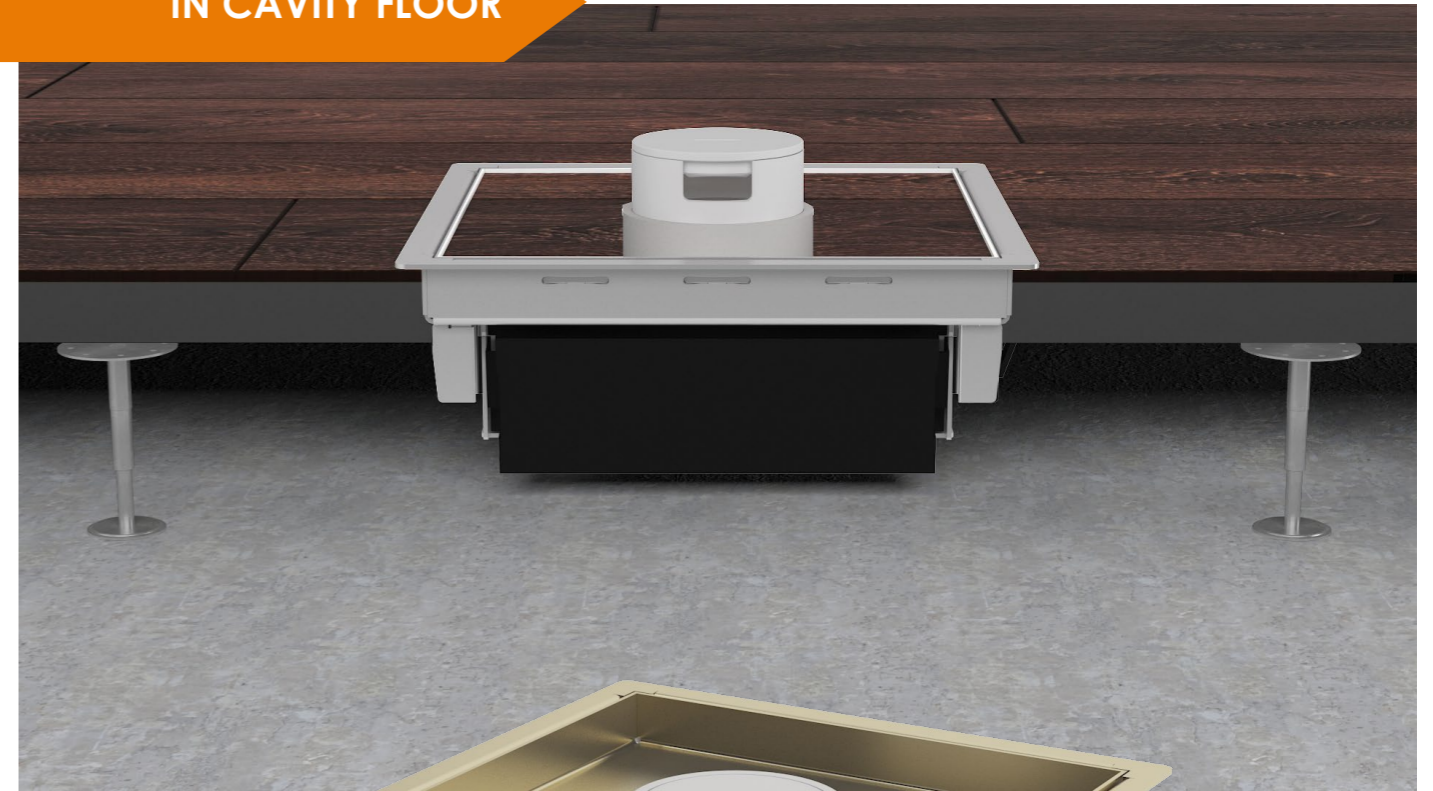

IN SCREED



For wet cleaned, dry-rated room

Floor cleaning should not leave puddles or cause the cassette covers to become wet. The underfloor system can be used in dry-rated rooms.



Risk of cable damage!

Cables connected to the cassette covers must only be routed through the cable outlet to avoid pinching! In all cases, care must be taken to ensure that the cable outlet is locked in position to prevent it from accidental closure!

C-series cassette covers

round cassette covers, for standard office load

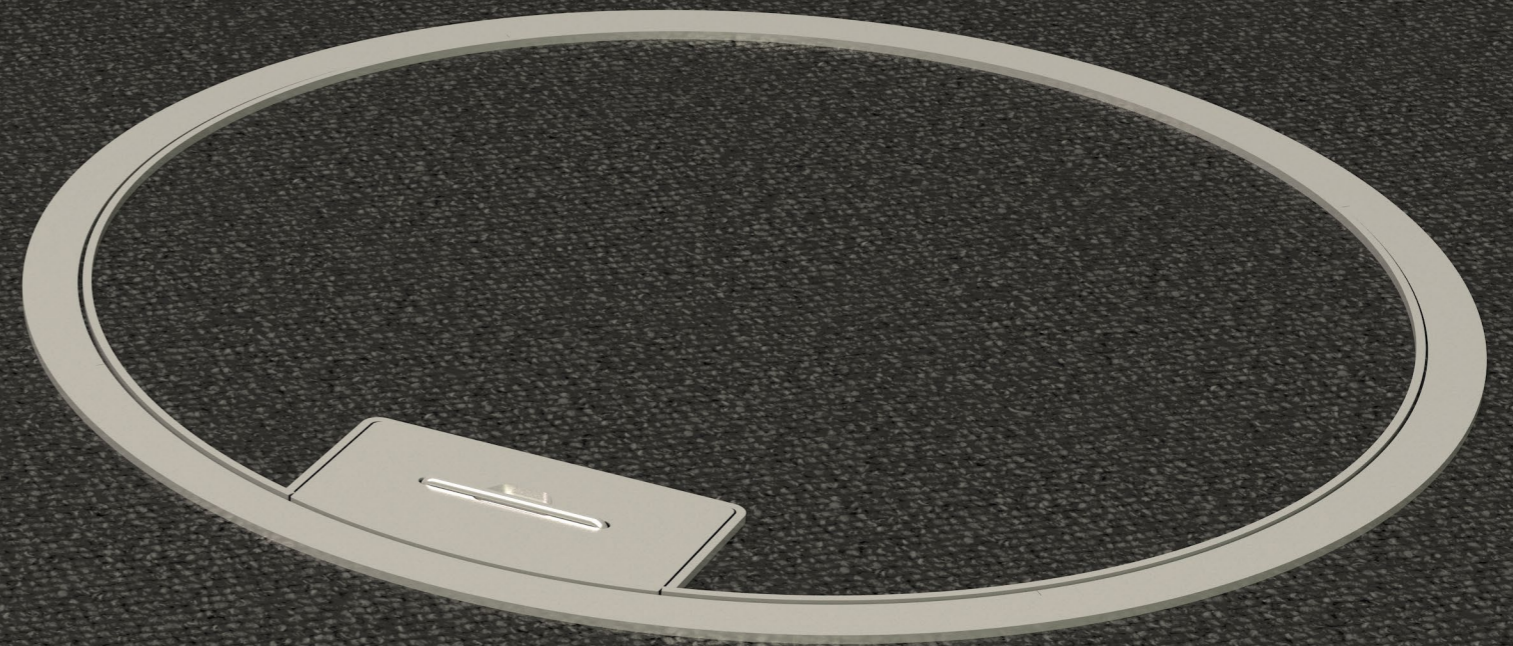
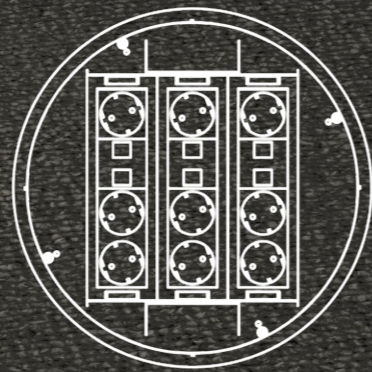
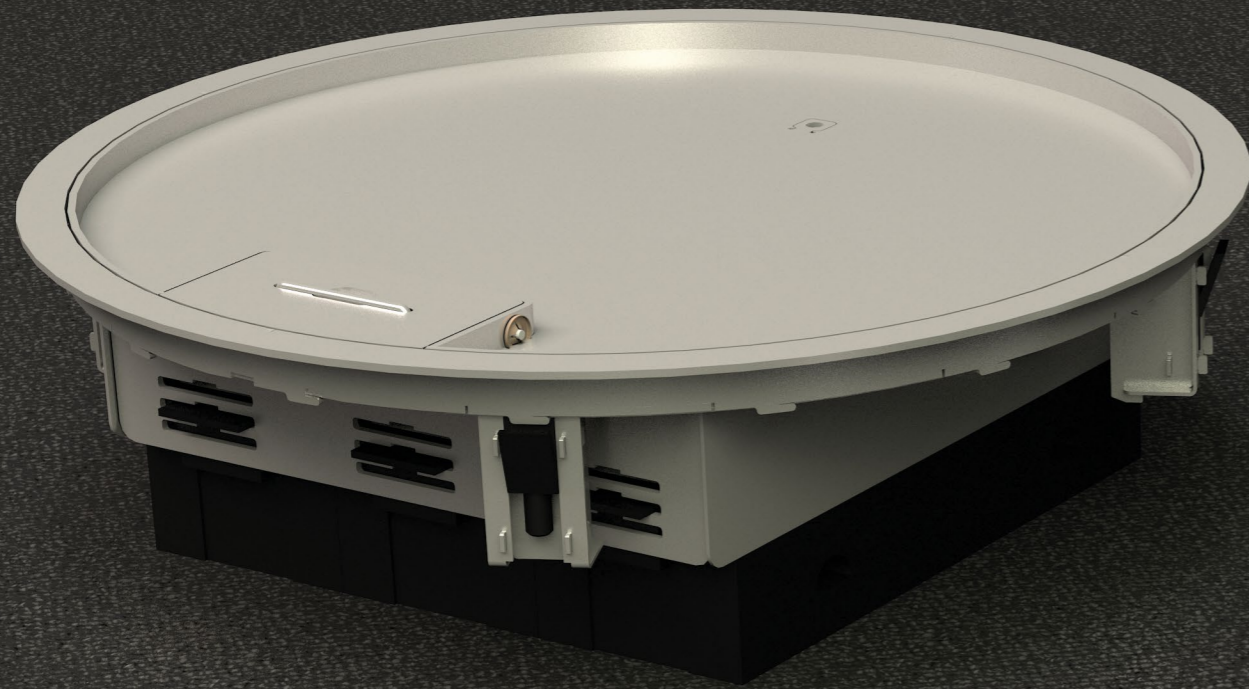

For 12 pcs. of MOSAIC 45 appliances with apparatus boxes



ECO-series cassette covers

for every requirement, for standard office load

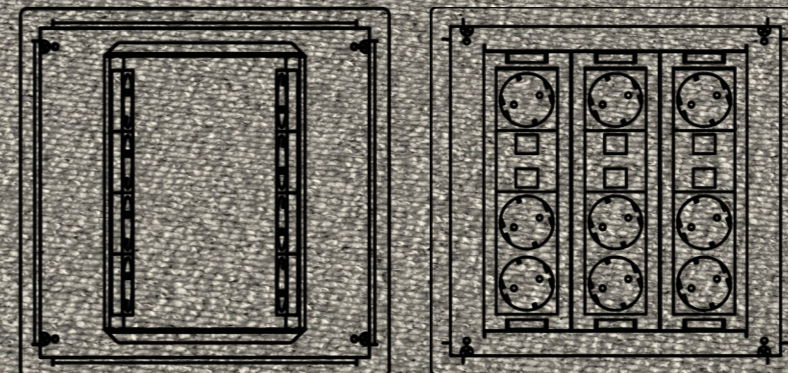
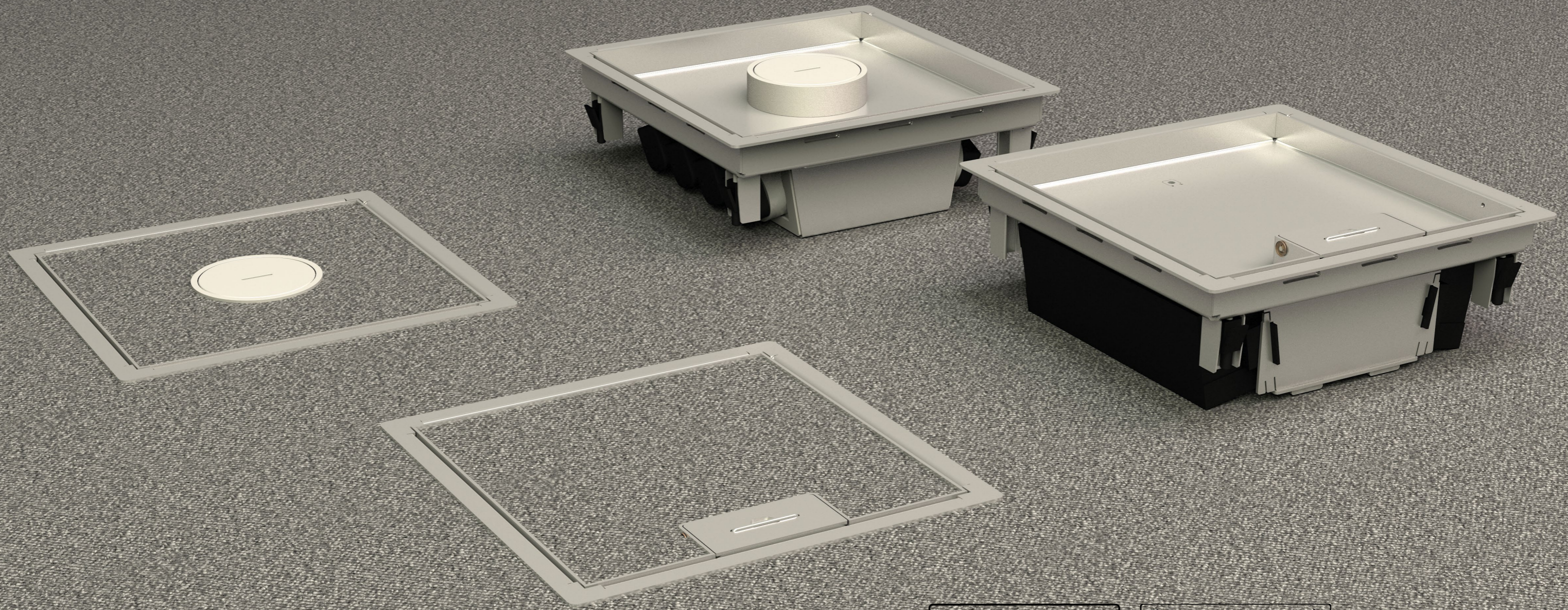

For 8 or 12 pcs. of MOSAIC 45 appliances with or without apparatus box, depending on type



ECO-series cassette covers

for every requirement, for standard office load

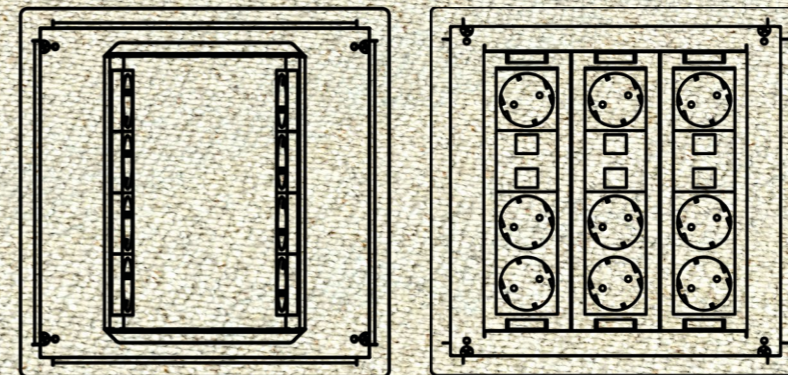
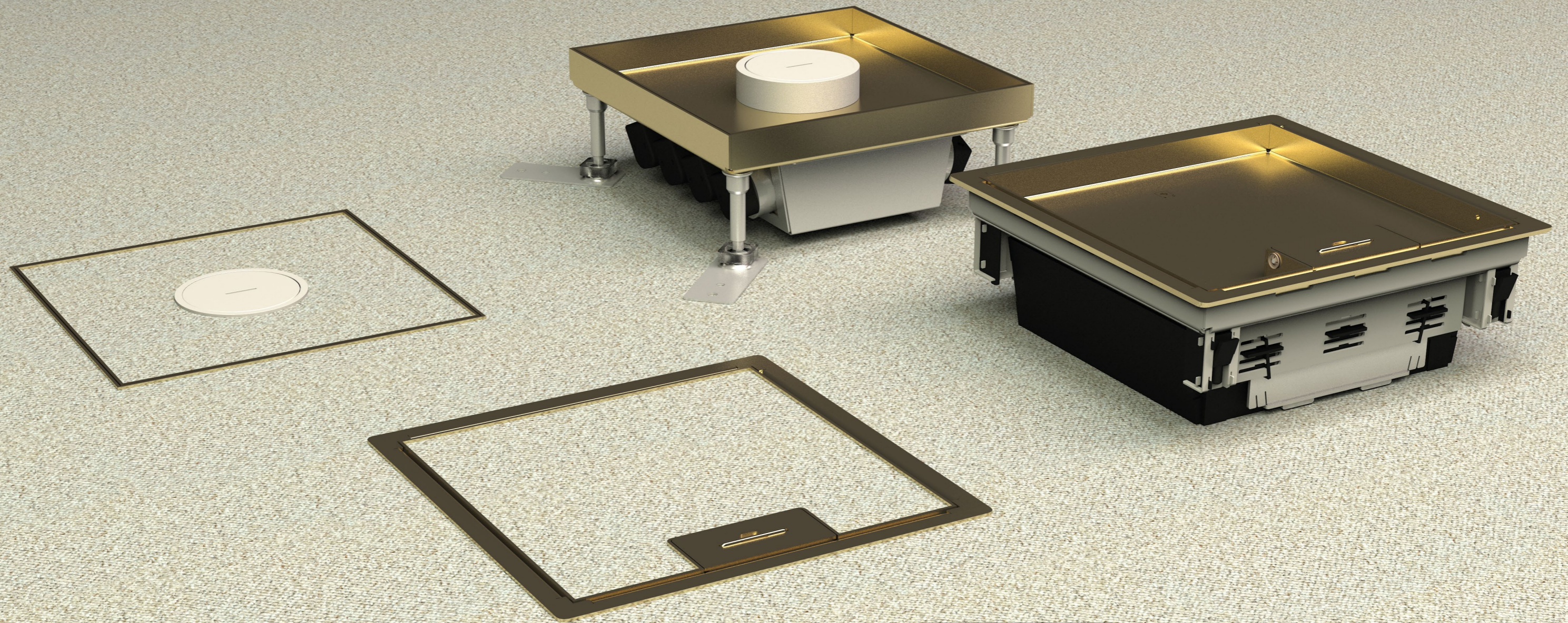

For 8 or 12 pcs. of MOSAIC 45 appliances with or without apparatus box, depending on type



F-series cassette covers

for high-traffic areas, for thicker floorings

Dimensions: 250mm×100-138mm×250mm



Dimensions: 200mm×100-138mm×250mm

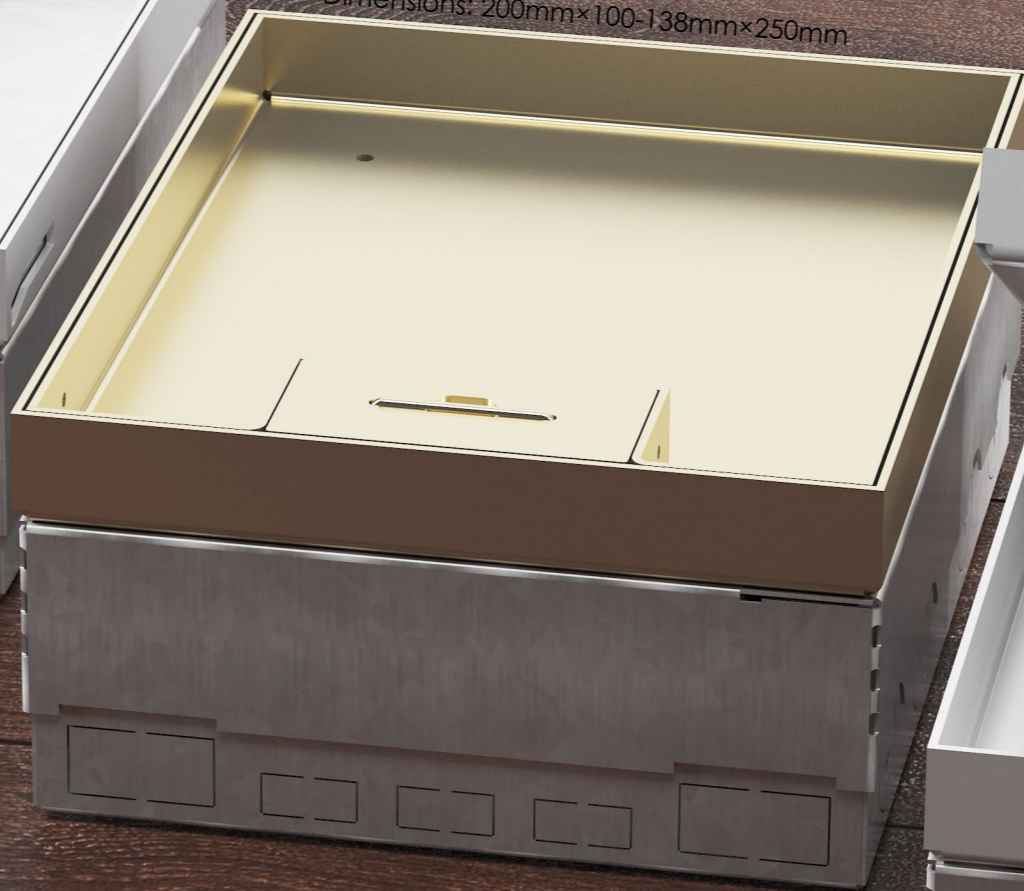

Dimensions: 140mm×100-138mm×250mm

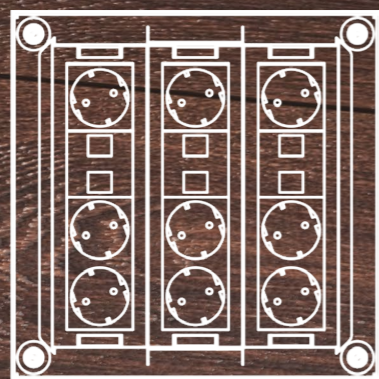

For 4 or 8 or 12 pcs. of MOSAIC 45 appliances with apparatus boxes

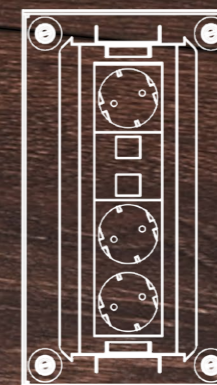
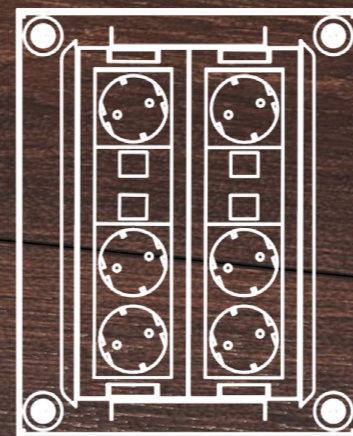

V-series cassette covers

for thinner flooring, for standard office load

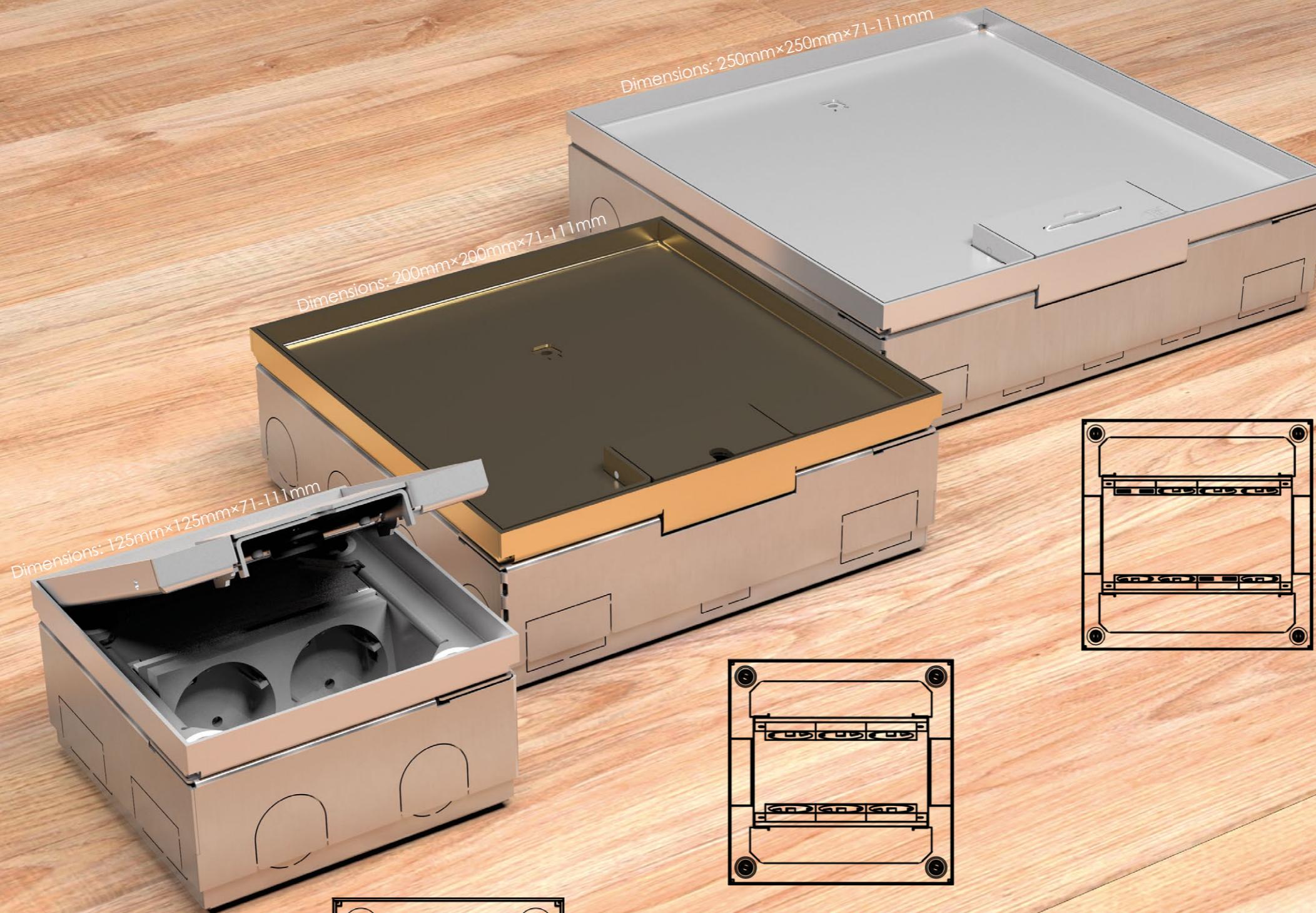

For 2 or 6 or 8 pcs. of MOSAIC 45 appliances

/CASSETTE COVERS

Cassette covers	Dimensions (mm)			Min. installation depth (mm)	Floor covering thickness (mm)	Number of appliances		Apparatus box		
	W.	L.	H.			pcs	type	pcs	type	
C305 Slim	Ø305			100-140	100	14	12	MOSAIC 45	3	GB3 569 8M
C305 Slim TK	Ø305			100	100	8	12	MOSAIC 45	3	GB3 569 8M
C305 Slim TSR	Ø305			100-140	100	14	12	MOSAIC 45	3	GB3 569 8M
ECO250 B	250	250	90-130/ 100-140	90/100	10/20	-	-	-	-	-
ECO250 BT	250	250	90-130/ 100-140	90/100	10/20	-	-	-	-	-
ECO250 BTK	250	250	60/70	60/70	10/20	-	-	-	-	-
ECO250 EL	250	250	90-130/ 100-140	90/100	10/20	8	MOSAIC 45	-	built-in	-
ECO250 ELK	250	250	80/90	80/90	10/20	8	MOSAIC 45	-	built-in	-
ECO250 ELT	250	250	90-130/ 100-140	90/100	10/20	8	MOSAIC 45	-	built-in	-
ECO250 ET	250	250	100-140	100	23	8	MOSAIC 45	-	built-in	-
ECO250 ETK	250	250	93	93	23	8	MOSAIC 45	-	built-in	-
ECO250 ETT	250	250	100-140	100	23	8	MOSAIC 45	-	built-in	-
ECO250 GL	250	250	90-130/ 100-140	90/100	10/20	8/ 12	MOSAIC 45	2/3	GB3 569 8M	-
ECO250 GLK	250	250	90/100	90/100	10/20	8/ 12	MOSAIC 45	2/3	GB3 569 8M	-
ECO250 GLT	250	250	90-130/ 100-140	90/100	10/20	8/ 12	MOSAIC 45	2/3	GB3 569 8M	-
ECO250 GT	250	250	100-140	100	23	8/ 12	MOSAIC 45	2/3	GB3 569 8M	-
ECO250 GTK	250	250	100	100	23	8/ 12	MOSAIC 45	2/3	GB3 569 8M	-
ECO250 GTT	250	250	100-140	100	23	8/ 12	MOSAIC 45	2/3	GB3 569 8M	-
F140S	140	250	100-138	100	19	4	MOSAIC 45	1	GB3 569 8M	-
F200S	200	250	100-138	100	19	8	MOSAIC 45	2	GB3 569 8M	-
F250S	250	250	100-138	100	19	12	MOSAIC 45	3	GB3 569 8M	-
V125/ V125 Slim	125	125	81-121/ 71-111	81/71	20/10	2	MOSAIC 45	-	built-in	-
V200/ V200 Slim	200	200	81-121/ 71-111	81/71	20/10	6	MOSAIC 45	-	built-in	-
V250/ V250 Slim	250	250	81-121/ 71-111	81/71	20/10	8	MOSAIC 45	-	built-in	-
V125 ST	125	125	71-111	71	10	2	MOSAIC 45	-	built-in	-
V200 ST	200	200	71-111	71	10	6	MOSAIC 45	-	built-in	-
V250 ST	250	250	71-111	71	10	8	MOSAIC 45	-	built-in	-

	Tube	Floor	Flooring	Frame	Under-floor box	Mounting lid		Inlay plate	
						UDH 2	UDH 3	Plastic	Metal
-	-	Cavity floor*	Tiles, wood floor	-	UDH 3	-	UDM3 Ø305	HPVC C305	BL C305 Rm
-	-	Cavity floor*	Carpeting, PVC	yes	UDH 3	-	UDM3 Ø305	-	BL C305 Rm
-	-	Cavity floor*	Carpeting, PVC	yes	UDH 3	-	UDM3 Ø305	HPVC C305	BL C305
-	-	Cavity floor*	Tiles, wood floor	-	UDH 2/ UDH 3	UDM2 250*250	UDM3 250*250	HPVC 250 B1	BL 250 B1
-	-	Cavity floor*	Carpeting, PVC	yes	UDH 2/ UDH 3	UDM2 250*250	UDM3 250*250	HPVC 250 B2	BL 250 B2
-	-	Cavity floor*	Carpeting, PVC	yes	UDH 2/ UDH 3	UDM2 250*250	UDM3 250*250	HPVC 250 B2	BL 250 B2
-	-	Cavity floor*	Tiles, wood floor	-	UDH 2/ UDH 3	UDM2 250*250	UDM3 250*250	HPVC 250	BL 250
-	-	Cavity floor*	Carpeting, PVC	yes	UDH 2/ UDH 3	UDM2 250*250	UDM3 250*250	HPVC 250 LE	BL 250 LE
-	-	Cavity floor*	Carpeting, PVC	yes	UDH 2/ UDH 3	UDM2 250*250	UDM3 250*250	HPVC 250 LE	BL 250 LE
yes	yes	Cavity floor*	Tiles, wood floor	-	UDH 2/ UDH 3	UDM2 250*250	UDM3 250*250	HPVC 250 TUM1	BL 250 TUM1
yes	yes	Cavity floor*	Carpeting, PVC	yes	UDH 2/ UDH 3	UDM2 250*250	UDM3 250*250	HPVC 250 TUM2	BL 250 TUM2
yes	yes	Cavity floor*	Carpeting, PVC	yes	UDH 2/ UDH 3	UDM2 250*250	UDM3 250*250	HPVC 250 TUM2	BL 250 TUM2
-	-	Cavity floor*	Tiles, wood floor	-	UDH 2/ UDH 3	UDM2 250*250	UDM3 250*250	HPVC 250	BL 250
-	-	Cavity floor*	Carpeting, PVC	yes	UDH 2/ UDH 3	UDM2 250*250	UDM3 250*250	HPVC 250 LE	BL 250 LE
-	-	Cavity floor*	Carpeting, PVC	yes	UDH 2/ UDH 3	UDM2 250*250	UDM3 250*250	HPVC 250 LE	BL 250 LE
yes	yes	Cavity floor*	Tiles, wood floor	-	UDH 2/ UDH 3	UDM2 250*250	UDM3 250*250	HPVC 250 TUM1	BL 250 TUM1
yes	yes	Cavity floor*	Carpeting, PVC	yes	UDH 2/ UDH 3	UDM2 250*250	UDM3 250*250	HPVC 250 TUM2	BL 250 TUM2
yes	yes	Cavity floor*	Carpeting, PVC	yes	UDH 2/ UDH 3	UDM2 250*250	UDM3 250*250	HPVC 250 TUM2	BL 250 TUM2
-	-	Screed	Tiles, wood floor	-	UDH 2/ UDH 3	UDM2 140*250	UDM3 140*250	HPVC F140	BL F140
-	-	Screed	Tiles, wood floor	-	UDH 2/ UDH 3	UDM2 200*250	UDM3 200*250	HPVC F200	BL F200
-	-	Screed	Tiles, wood floor	-	UDH 2/ UDH 3	UDM2 250*250	UDM3 250*250	HPVC 250	BL 250
-	-	Screed	Tiles, wood floor	-	UDH 2/ UDH 3	UDM2 125*125	UDM3 125*125	HPVC V125	BL V125
-	-	Screed	Tiles, wood floor	-	UDH 2/ UDH 3	UDM2 200*200	UDM3 200*200	HPVC V200	BL V200
-	-	Screed	Tiles, wood floor	-	UDH 2/ UDH 3	UDM2 250*250	UDM3 250*250	HPVC 250	BL 250
-	-	Screed	Tiles, wood floor	yes	UDH 2/ UDH 3	UDM2 125*125	UDM3 125*125	-	-
-	-	Screed	Tiles, wood floor	yes	UDH 2/ UDH 3	UDM2 200*200	UDM3 200*200	-	-
-	-	Screed	Tiles, wood floor	yes	UDH 2/ UDH 3	UDM2 250*250	UDM3 250*250	HPVC 250 LE	BL 250

*Underfloor box is required for mounting in screed. See page 16.

/CASSETTE COVERS

CASSETTE COVERS FOR CAVITY FLOOR

C305 Slim TK - round cassette cover



Article	Dimensions (mm)			Floor covering thickness (mm)	Appliances Nr. (pcs)	PU. (pcs)	Wgt. (kg)	EAN	Order number
	W.	L.	H.						
C305 Slim TK LE/E3	Ø305	100	8	8	12	1	4	77120 47	950C305PKQ12LE/E3
C305 Slim TK LE/CU	Ø305	100	8	8	12	1	4	77132 35	950C305PKQ12LE/CU

Round cassette cover for cavity floor, Ø305 mm, for 12 appliances.
With floor covering protection frame and fixing brackets for cavity floor.
Available in stainless steel (W. Nr. 1.4301) or brass (CuZn).
For 3 pcs. of GB3 569 8M apparatus boxes, for 12 pcs. of MOSAIC 45 appliances.
Primarily for carpeting or PVC.
Mounting in screed is possible with UDM3 Ø305 mounting lid with UDH 3 underfloor box.
Load capacity: max. 150 kg

ECO250 BTK - blind cassette



Article	Dimensions (mm)			Floor covering thickness (mm)	Appliances Nr. (pcs)	PU. (pcs)	Wgt. (kg)	EAN	Order number
	W.	L.	H.						
ECO250 BTK LE/E3	250	250	70	20	-	1	2,3	77124 67	950ECO250Q00LE/E3 BTK
ECO250 BTK LE/CU	250	250	70	20	-	1	2,3	77132 42	950ECO250Q00LE/CU BTK
ECO250S BTK LE/E3	250	250	60	10	-	1	2,1	77132 59	950ECO250S00LE/E3 BTK
ECO250S BTK LE/CU	250	250	60	10	-	1	2,1	77132 66	950ECO250S00LE/CU BTK

Blind cassette cover for cavity floor, 250×250 mm. Inspection cover.
With floor covering protection frame and fixing brackets for cavity floor.
Available in stainless steel (W. Nr. 1.4301) or brass (CuZn).
Primarily for carpeting or PVC.
Mounting in screed is possible with using UDM2 250×250 mounting lid with UDH 2 underfloor box, or using UDM3 250×250 mounting lid with UDH 3 underfloor box.
Load capacity: max. 150 kg

ECO250 ELK



Article	Dimensions (mm)			Floor covering thickness (mm)	Appliances Nr. (pcs)	PU. (pcs)	Wgt. (kg)	EAN	Order number
	W.	L.	H.						
ECO250 ELK LE/E3	250	250	90	20	8	1	3,9	77119 72	950ECO250Q08LE/E3 ELK
ECO250 ELK LE/CU	250	250	90	20	8	1	3,9	77132 73	950ECO250Q08LE/CU ELK
ECO250S ELK LE/E3	250	250	80	10	8	1	3,7	77132 80	950ECO250S08LE/E3 ELK
ECO250S ELK LE/CU	250	250	80	10	8	1	3,7	77132 97	950ECO250S08LE/CU ELK

Cassette cover for cavity floor, 250×250 mm, for 8 appliances.
With floor covering protection frame and fixing brackets for cavity floor.
Available in stainless steel (W. Nr. 1.4301) or brass (CuZn).
For 8 pcs. of MOSAIC 45 appliances.
Primarily for carpeting or PVC.
Mounting in screed is possible with using UDM2 250×250 mounting lid with UDH 2 underfloor box, or using UDM3 250×250 mounting lid with UDH 3 underfloor box.
Load capacity: max. 150 kg

ECO250 ETK



Article	Dimensions (mm)			Floor covering thickness (mm)	Appliances Nr. (pcs)	PU. (pcs)	Wgt. (kg)	EAN	Order number
	W.	L.	H.						
ECO250 ETK LE/E3	250	250	93	23	8	1	3,9	77124 74	950ECO250Q08LE/E3 ETK
ECO250 ETK LE/CU	250	250	93	23	8	1	3,9	77133 03	950ECO250Q08LE/CU ETK

Cassette cover for cavity floor, 250×250 mm, for 8 appliances.
With tube cable outlet, floor covering protection frame and fixing brackets for cavity floor.
Available in stainless steel (W. Nr. 1.4301) or brass (CuZn).
For 8 pcs. of MOSAIC 45 appliances.
Primarily for carpeting or PVC.
Mounting in screed is possible with using UDM2 250×250 mounting lid with UDH 2 underfloor box, or using UDM3 250×250 mounting lid with UDH 3 underfloor box.
Load capacity: max. 150 kg

CASSETTE COVERS\

ECO250 GLK



Article	Dimensions (mm)			Floor covering thickness (mm)	Appliances Nr. (pcs)	PU. (pcs)	Wgt. (kg)	EAN	Order number
	W.	L.	H.						
ECO250 GLK LE/E3	250	250	100	20	8	1	3,9	77118 97	950ECO250Q08LE/E3 GLK
ECO250 GLK LE/CU	250	250	100	20	8	1	3,9	77133 10	950ECO250Q08LE/CU GLK
ECO250S GLK LE/E3	250	250	90	10	8	1	3,7	77133 27	950ECO250S08LE/E3 GLK
ECO250S GLK CU	250	250	90	10	8	1	3,7	77133 34	950ECO250S08LE/CU GLK
ECO250 GLK Q12 LE/E3	250	250	100	20	12	1	3,9	77133 41	950ECO250Q12LE/E3 GLK
ECO250 GLK Q12 LE/CU	250	250	100	20	12	1	3,9	77133 58	950ECO250Q12LE/CU GLK
ECO250S GLK Q12 LE/E3	250	250	90	10	12	1	3,7	77133 65	950ECO250S12LE/E3 GLK
ECO250S GLK Q12 LE/CU	250	250	90	10	12	1	3,7	77133 72	950ECO250S12LE/CU GLK

Cassette cover for cavity floor, 250×250 mm, for 8 or 12 appliances.
With floor covering protection frame and fixing brackets for cavity floor.
Available in stainless steel (W. Nr. 1.4301) or brass (CuZn).
For GB3 569 8M apparatus box, for MOSAIC 45 appliances.
Primarily for carpeting or PVC.
Mounting in screed is possible with using UDM2 250×250 mounting lid with UDH 2 underfloor box, or using UDM3 250×250 mounting lid with UDH 3 underfloor box.
Load capacity: max. 150 kg

ECO250 GTK



Article	Dimensions (mm)			Floor covering thickness (mm)	Appliances Nr. (pcs)	PU. (pcs)	Wgt. (kg)	EAN	Order number
	W.	L.	H.						
ECO250 GTK LE/E3	250	250	100	23	8	1	4,2	77124 81	950ECO250Q08LE/E3 GTK
ECO250 GTK LE/CU	250	250	100	23	8	1	4,2	77133 89	950ECO250Q08LE/CU GTK
ECO250 GTK Q12 LE/E3	250	250	100	23	12	1	4,2	77133 96	950ECO250Q12LE/E3 GTK
ECO250 GTK Q12 LE/CU	250	250	100	23	12	1	4,2	77134 02	950ECO250Q12LE/CU GTK

Cassette cover for cavity floor, 250×250 mm, for 8 or 12 appliances.
With tube cable outlet, floor covering protection frame and fixing brackets for cavity floor.
Available in stainless steel (W. Nr. 1.4301) or brass (CuZn).
For GB3 569 8M apparatus box, for MOSAIC 45 appliances.
Primarily for carpeting or PVC.
Mounting in screed is possible with using UDM2 250×250 mounting lid with UDH 2 underfloor box, or using UDM3 250×250 mounting lid with UDH 3 underfloor box.
Load capacity: max. 150 kg

/CASSETTE COVERS

CASSETTE COVERS WITH HEIGHT-ADJUSTABLE LEVELING UNITS

C305 Slim - round cassette cover



Article	Dimensions (mm)			Floor covering thickness (mm)	Appliances Nr. (pcs)	PU. (pcs)	Wgt. (kg)	EAN	Order number
	W.	L.	H.						
C305 Slim LE/E3	Ø305	100-140	14	12	1	4,7	77120 54		950C305SQ12LE/E3
C305 Slim LE/CU	Ø305	100-140	14	12	1	4,7	77134 19		950C305SQ12LE/CU

Round cassette cover for cavity floor, Ø305 mm, for 12 appliances.
With high-adjustable leveling unit. Leveling range: 100-140 mm.
Available in stainless steel (W. Nr. 1.4301) or brass (CuZn).
For 3 pcs. of GB3 569 8M apparatus boxes, for 12 pcs. of MOSAIC 45 appliances.
Primarily for tiles, wood floor.
Mounting in screed is possible with UDM3 Ø305 mounting lid with UDH 3 underfloor box.
Load capacity: max. 150 kg

C305 Slim TSR - round cassette cover



Article	Dimensions (mm)			Floor covering thickness (mm)	Appliances Nr. (pcs)	PU. (pcs)	Wgt. (kg)	EAN	Order number
	W.	L.	H.						
C305 Slim TSR LE/E3	Ø305	100-140	14	12	1	4,1	77119 34		950C305PQ12LE/E3
C305 Slim TSR LE/CU	Ø305	100-140	14	12	1	4,1	77134 26		950C305PQ12LE/CU

Round cassette cover for cavity floor, Ø305 mm, for 12 appliances.
With carpet protection frame and high-adjustable leveling unit. Leveling range: 100-140 mm.
Available in stainless steel (W. Nr. 1.4301) or brass (CuZn).
For 3 pcs. of GB3 569 8M apparatus boxes, for 12 pcs. of MOSAIC 45 appliances.
Primarily for carpeting or PVC.
Mounting in screed is possible with UDM3 Ø305 mounting lid with UDH 3 underfloor box.
Load capacity: max. 150 kg

ECO250 B - blind cassette cover



Article	Dimensions (mm)			Floor covering thickness (mm)	Appliances Nr. (pcs)	PU. (pcs)	Wgt. (kg)	EAN	Order number
	W.	L.	H.						
ECO250 B LE/E3	250	250	100-140	20	-	1	2,2	77119 41	950ECO250Q00LE/E3 B
ECO250 B LE/CU	250	250	100-140	20	-	1	2,2	77134 33	950ECO250Q00LE/CU B
ECO250S B LE/E3	250	250	90-130	10	-	1	2	77134 40	950ECO250S00LE/E3 B
ECO250S B LE/CU	250	250	90-130	10	-	1	2	77134 57	950ECO250S00LE/CU B

Blind cassette cover for cavity floor, 250×250 mm. Inspection cover.
With high-adjustable leveling unit. Leveling range: 90-130 mm and 100-140 mm.
Available in stainless steel (W. Nr. 1.4301) or brass (CuZn).
Primarily for tiles, wood floor.
Mounting in screed is possible with using UDM2 250×250 mounting lid with UDH 2 underfloor box, or using UDM3 250×250 mounting lid with UDH 3 underfloor box.
Load capacity: max. 150 kg

ECO250 BT - blind cassette cover



Article	Dimensions (mm)			Floor covering thickness (mm)	Appliances Nr. (pcs)	PU. (pcs)	Wgt. (kg)	EAN	Order number
	W.	L.	H.						
ECO250 BT LE/E3	250	250	100-140	20	-	1	2,4	77119 58	950ECO250Q00LE/E3 BT
ECO250 BT LE/CU	250	250	100-140	20	-	1	2,4	77134 64	950ECO250Q00LE/CU BT
ECO250S BT LE/E3	250	250	90-130	10	-	1	2,2	77134 71	950ECO250S00LE/E3 BT
ECO250S BT LE/CU	250	250	90-130	10	-	1	2,2	77134 88	950ECO250S00LE/CU BT

Blind cassette cover for cavity floor, 250×250 mm. Inspection cover.
With carpet protection frame and high-adjustable leveling unit. Leveling range: 90-130 mm and 100-140 mm.
Available in stainless steel (W. Nr. 1.4301) or brass (CuZn).
Primarily for carpeting or PVC.
Mounting in screed is possible with using UDM2 250×250 mounting lid with UDH 2 underfloor box, or using UDM3 250×250 mounting lid with UDH 3 underfloor box.
Load capacity: max. 150 kg

CASSETTE COVERS\

ECO250 EL



Article	Dimensions (mm)			Floor covering thickness (mm)	Appliances Nr. (pcs)	PU. (pcs)	Wgt. (kg)	EAN	Order number
	W.	L.	H.						
ECO250 EL LE/E3	250	250	100-140	20	8	1	3,6	77119 65	950ECO250Q08LE/E3 EL
ECO250 EL LE/CU	250	250	100-140	20	8	1	3,6	77134 95	950ECO250Q08LE/CU EL
ECO250S EL LE/E3	250	250	90-130	10	8	1	3,4	77135 01	950ECO250S08LE/E3 EL
ECO250S EL LE/CU	250	250	90-130	10	8	1	3,4	77135 18	950ECO250S08LE/CU EL

Cassette cover for cavity floor, 250×250 mm, for 8 appliances.
With high-adjustable leveling unit. Leveling range: 90-130 mm and 100-140 mm.
Available in stainless steel (W. Nr. 1.4301) or brass (CuZn).
For 8 pcs. of MOSAIC 45 appliances.
Primarily for tiles, wood floor.
Mounting in screed is possible with using UDM2 250×250 mounting lid with UDH 2 underfloor box, or using UDM3 250×250 mounting lid with UDH 3 underfloor box.
Load capacity: max. 150 kg

ECO250 ELT



Article	Dimensions (mm)			Floor covering thickness (mm)	Appliances Nr. (pcs)	PU. (pcs)	Wgt. (kg)	EAN	Order number
	W.	L.	H.						
ECO250 ELT LE/E3	250	250	100-140	20	8	1	3,9	77119 27	950ECO250Q08LE/E3 ELT
ECO250 ELT LE/CU	250	250	100-140	20	8	1	3,9	77135 25	950ECO250Q08LE/CU ELT
ECO250S ELT LE/E3	250	250	90-130	10	8	1	3,7	77135 32	950ECO250S08LE/E3 ELT
ECO250S ELT LE/CU	250	250	90-130	10	8	1	3,7	77135 49	950ECO250S08LE/CU ELT

Cassette cover for cavity floor, 250×250 mm, for 8 appliances.
With carpet protection frame and high-adjustable leveling unit. Leveling range: 90-130 mm and 100-140 mm.
Available in stainless steel (W. Nr. 1.4301) or brass (CuZn).
For 8 pcs. of MOSAIC 45 appliances.
Primarily for carpeting or PVC.
Mounting in screed is possible with using UDM2 250×250 mounting lid with UDH 2 underfloor box, or using UDM3 250×250 mounting lid with UDH 3 underfloor box.
Load capacity: max. 150 kg

ECO250 ET



Article	Dimensions (mm)			Floor covering thickness (mm)	Appliances Nr. (pcs)	PU. (pcs)	Wgt. (kg)	EAN	Order number
	W.	L.	H.						
ECO250 ET LE/E3	250	250	100-140	23	8	1	3,9	77119 89	950ECO250Q08LE/E3 ET
ECO250 ET LE/CU	250	250	100-140	23	8	1	3,9	77135 56	950ECO250Q08LE/CU ET

Cassette cover for cavity floor, 250×250 mm, for 8 appliances.
With tube cable outlet and high-adjustable leveling unit. Leveling range: 100-140 mm.
Available in stainless steel (W. Nr. 1.4301) or brass (CuZn).
For 8 pcs. of MOSAIC 45 appliances.
Primarily for tiles, wood floor.
Mounting in screed is possible with using UDM2 250×250 mounting lid with UDH 2 underfloor box, or using UDM3 250×250 mounting lid with UDH 3 underfloor box.
Load capacity: max. 150 kg

/CASSETTE COVERS

ECO250 ETT



Article	Dimensions (mm)			Floor covering thickness (mm)	Appliances Nr. (pcs)	PU. (pcs)	Wgt. (kg)	EAN	Order number
	W.	L.	H.						
ECO250 ETT LE/E3	250	250	100-140	23	8	1	4	77119 96	950ECO250Q08LE/E3 ETT
ECO250 ETT LE/CU	250	250	100-140	23	8	1	4	77135 63	950ECO250Q08LE/CU ETT

Cassette cover for cavity floor, 250×250 mm, for 8 appliances.
With tube cable outlet, floor covering protection frame and hight-adjustable leveling unit. Leveling range: 100-140 mm.
Available in stainless steel (W. Nr. 1.4301) or brass (CuZn).
For 8 pcs. of MOSAIC 45 appliances.
Primarily for carpeting or PVC.
Mounting in screed is possible with using UDM2 250×250 mounting lid with UDH 2 underfloor box, or using UDM3 250×250 mounting lid with UDH 3 underfloor box.
Load capacity: max. 150 kg

ECO250 GL



Article	Dimensions (mm)			Floor covering thickness (mm)	Appliances Nr. (pcs)	PU. (pcs)	Wgt. (kg)	EAN	Order number
	W.	L.	H.						
ECO250 GL LE/E3	250	250	100-140	20	8	1	3,8	77120 09	950ECO250Q08LE/E3 GL
ECO250 GL LE/CU	250	250	100-140	20	8	1	3,8	77135 70	950ECO250Q08LE/CU GL
ECO250S GL LE/E3	250	250	90-130	10	8	1	3,6	77135 87	950ECO250S08LE/E3 GL
ECO250S GL LE/CU	250	250	90-130	10	8	1	3,6	77135 94	950ECO250S08LE/CU GL
ECO250 GL Q12 LE/E3	250	250	100-140	20	12	1	3,8	77136 00	950ECO250Q12LE/E3 GL
ECO250 GL Q12 LE/CU	250	250	100-140	20	12	1	3,8	77136 17	950ECO250Q12LE/CU GL
ECO250S GL Q12 LE/E3	250	250	90-130	10	12	1	3,6	77136 24	950ECO250S12LE/E3 GL
ECO250S GL Q12 LE/CU	250	250	90-130	10	12	1	3,6	77136 31	950ECO250S12LE/CU GL

Cassette cover for cavity floor, 250×250 mm, for 8 or 12 appliances.
With high-adjustable leveling unit. Leveling range: 90-130 mm and 100-140 mm.
Available in stainless steel (W. Nr. 1.4301) or brass (CuZn).
For GB3 569 8M apparatus box, for MOSAIC 45 appliances.
Primarily for tiles, wood floor.
Mounting in screed is possible with using UDM2 250×250 mounting lid with UDH 2 underfloor box, or using UDM3 250×250 mounting lid with UDH 3 underfloor box.
Load capacity: max. 150 kg

ECO250 GLT



Article	Dimensions (mm)			Floor covering thickness (mm)	Appliances Nr. (pcs)	PU. (pcs)	Wgt. (kg)	EAN	Order number
	W.	L.	H.						
ECO250 GLT LE/E3	250	250	100-140	20	8	1	3,9	77119 10	950ECO250Q08LE/E3 GLT
ECO250 GLT LE/CU	250	250	100-140	20	8	1	3,9	77136 48	950ECO250Q08LE/CU GLT
ECO250S GLT LE/E3	250	250	90-130	10	8	1	3,7	77136 55	950ECO250S08LE/E3 GLT
ECO250S GLT LE/CU	250	250	90-130	10	8	1	3,7	77136 62	950ECO250S08LE/CU GLT
ECO250 GLT Q12 LE/E3	250	250	100-140	20	12	1	3,9	77136 79	950ECO250Q12LE/E3 GLT
ECO250 GLT Q12 LE/CU	250	250	100-140	20	12	1	3,9	77136 86	950ECO250Q12LE/CU GLT
ECO250S GLT Q12 LE/E3	250	250	90-130	10	12	1	3,7	77136 93	950ECO250S12LE/E3 GLT
ECO250S GLT Q12 LE/CU	250	250	90-130	10	12	1	3,7	77137 09	950ECO250S12LE/CU GLT

Cassette cover for cavity floor, 250×250 mm, for 8 or 12 appliances.
With carpet protection frame and high-adjustable leveling unit. Leveling range: 90-130 mm and 100-140 mm.
Available in stainless steel (W. Nr. 1.4301) or brass (CuZn).
For GB3 569 8M apparatus box, for MOSAIC 45 appliances.
Primarily for carpeting or PVC.
Mounting in screed is possible with using UDM2 250×250 mounting lid with UDH 2 underfloor box, or using UDM3 250×250 mounting lid with UDH 3 underfloor box.
Load capacity: max. 150 kg

CASSETTE COVERS\

ECO250 GT

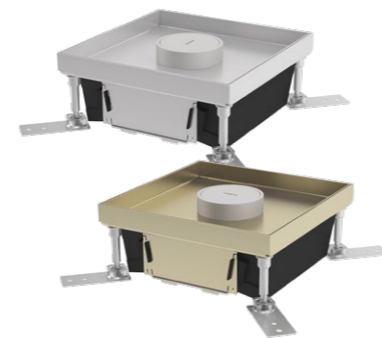

Article	Dimensions (mm)			Floor covering thickness (mm)	Appliances Nr. (pcs)	PU. (pcs)	Wgt. (kg)	EAN	Order number
	W.	L.	H.						
ECO250 GT LE/E3	250	250	100-140	23	8	1	4,1	77120 16	950ECO250Q08LE/E3 GT
ECO250 GT LE/CU	250	250	100-140	23	8	1	4,1	77137 16	950ECO250Q08LE/CU GT
ECO250 GT Q12 LE/E3	250	250	100-140	23	12	1	4,1	77137 23	950ECO250Q12LE/E3 GT
ECO250 GT Q12 LE/CU	250	250	100-140	23	12	1	4,1	77137 30	950ECO250Q12LE/CU GT

Cassette cover for cavity floor, 250×250 mm, for 8 or 12 appliances.
With tube cable outlet and high-adjustable leveling unit. Leveling range: 100-140 mm.
Available in stainless steel (W. Nr. 1.4301) or brass (CuZn).
For GB3 569 8M apparatus box, for MOSAIC 45 appliances.
Primarily for tiles, wood floor.
Mounting in screed is possible with using UDM2 250×250 mounting lid with UDH 2 underfloor box, or using UDM3 250×250 mounting lid with UDH 3 underfloor box.
Load capacity: max. 150 kg

ECO250 GTT



Article	Dimensions (mm)			Floor covering thickness (mm)	Appliances Nr. (pcs)	PU. (pcs)	Wgt. (kg)	EAN	Order number
	W.	L.	H.						
ECO250 GTT LE/E3	250	250	100-140	23	8	1	4,2	77120 23	950ECO250Q08LE/E3 GTT
ECO250 GTT LE/CU	250	250	100-140	23	8	1	4,2	77137 47	950ECO250Q08LE/CU GTT
ECO250 GTT Q12 LE/E3	250	250	100-140	23	12	1	4,2	77137 54	950ECO250Q12LE/E3 GTT
ECO250 GTT Q12 LE/CU	250	250	100-140	23	12	1	4,2	77137 61	950ECO250Q12LE/CU GTT

Cassette cover for cavity floor, 250×250 mm, for 8 or 12 appliances.
With tube cable outlet, floor covering protection frame and high-adjustable leveling unit. Leveling range: 100-140 mm.
Available in stainless steel (W. Nr. 1.4301) or brass (CuZn).
For GB3 569 8M apparatus box, for MOSAIC 45 appliances.
Primarily for carpeting or PVC.
Mounting in screed is possible with using UDM2 250×250 mounting lid with UDH 2 underfloor box, or using UDM3 250×250 mounting lid with UDH 3 underfloor box.
Load capacity: max. 150 kg

/CASSETTE COVERS

CASSETTE COVERS FOR SCREED (ESTRICH)

F140S



Article	Dimensions (mm)			Floor covering thickness (mm)	Appliances Nr. (pcs)	PU. (pcs)	Wgt. (kg)	EAN	Order number
	W.	L.	H.						
F140S LE/E3	140	250	100-138	19	4	1	3,8	77115 45	950F140SE4LE/E3
F140S LE/CU	140	250	100-138	19	4	1	3,8	77118 11	950F140SE4LE/CU

Cassette cover for screed 140×250 mm, for 4 appliances.
Leveling range: 100-138 mm, min. installation depth: 100 mm.
Available in stainless steel (W. Nr. 1.4301) or brass (CuZn).
For 1 pcs. of GB3 569 8M apparatus boxes, for 4 pcs. of MOSAIC 45 appliances.
Primarily for tiles, wood floor.
High load carrying capacity: 250 kg with +3 mm steel reinforcement.

F200S



Article	Dimensions (mm)			Floor covering thickness (mm)	Appliances Nr. (pcs)	PU. (pcs)	Wgt. (kg)	EAN	Order number
	W.	L.	H.						
F200S LE/E3	200	250	100-138	19	8	1	4,6	77115 69	950F200SE8LE/E3
F200S LE/CU	200	250	100-138	19	8	1	4,6	77117 05	950F200SE8LE/CU

Cassette cover for screed 200×250 mm, for 8 appliances.
Leveling range: 100-138 mm, min. installation depth: 100 mm.
Available in stainless steel (W. Nr. 1.4301) or brass (CuZn).
For 2 pcs. of GB3 569 8M apparatus boxes, for 8 pcs. of MOSAIC 45 appliances.
Primarily for tiles, wood floor.
High load carrying capacity: 250 kg with +3 mm steel reinforcement.

F250S



Article	Dimensions (mm)			Floor covering thickness (mm)	Appliances Nr. (pcs)	PU. (pcs)	Wgt. (kg)	EAN	Order number
	W.	L.	H.						
F250S LE/E3	250	250	100-138	19	12	1	5,4	77115 83	950F250SQ12LE/E3
F250S LE/CU	250	250	100-138	19	12	1	5,4	77117 12	950F250SQ12LE/CU

Cassette cover for screed 250×250 mm, for 12 appliances.
Leveling range: 100-138 mm, min. installation depth: 100 mm.
Available in stainless steel (W. Nr. 1.4301) or brass (CuZn).
For 3 pcs. of GB3 569 8M apparatus boxes, for 12 pcs. of MOSAIC 45 appliances.
Primarily for tiles, wood floor.
High load carrying capacity: 250 kg with +3 mm steel reinforcement.

CASSETTE COVERS\

V125



Article	Dimensions (mm)			Floor covering thickness (mm)	Appliances Nr. (pcs)	PU. (pcs)	Wgt. (kg)	EAN	Order number
	W.	L.	H.						
V125 Slim LE/E3	125	125	71-111	10	2	1	1,6	77117 29	950V125SLIME2LE/E3
V125 Slim LE/CU	125	125	71-111	10	2	1	1,6	77117 98	950V125SLIME2LE/CU
V125 LE/E3	125	125	81-121	20	2	1	1,8	77137 78	950V1250000E2LE/E3
V125 LE/CU	125	125	81-121	20	2	1	1,8	77137 85	950V1250000E2LE/CU

Cassette cover for screed, 125×125 mm, for 2 appliances.
Leveling range: 71-111 mm and 81-121 mm, min. installation depth: 71 mm, or 81 mm.
Available in stainless steel (W. Nr. 1.4301) or brass (CuZn).
For 2 pcs. of MOSAIC 45 appliances.
Primarily for tiles, wood floor.
Load capacity: max. 150 kg

V200



Article	Dimensions (mm)			Floor covering thickness (mm)	Appliances Nr. (pcs)	PU. (pcs)	Wgt. (kg)	EAN	Order number
	W.	L.	H.						
V200 Slim LE/E3	200	200	71-111	10	6	1	2,9	77117 36	950V200SLIME6LE/E3
V200 Slim LE/CU	200	200	71-111	10	6	1	2,9	77118 42	950V200SLIME6LE/CU
V200 LE/E3	200	200	81-121	20	6	1	3,1	77137 92	950V2000000E6LE/E3
V200 LE/CU	200	200	81-121	20	6	1	3,1	77138 08	950V2000000E6LE/CU

Cassette cover for screed 200×200 mm, for 6 appliances.
Leveling range: 71-111 mm and 81-121 mm, min. installation depth: 71 mm, or 81 mm.
Available in stainless steel (W. Nr. 1.4301) or brass (CuZn).
For 6 pcs. of MOSAIC 45 appliances.
Primarily for tiles, wood floor.
Load capacity: max. 150 kg

V250



Article	Dimensions (mm)			Floor covering thickness (mm)	Appliances Nr. (pcs)	PU. (pcs)	Wgt. (kg)	EAN	Order number
	W.	L.	H.						
V250 Slim LE/E3	250	250	71-111	10	8	1	3,9	77117 43	950V250SLIME8LE/E3
V250 Slim LE/CU	250	250	71-111	10	8	1	3,9	77118 04	950V250SLIME8LE/CU
V250 LE/E3	250	250	81-121	20	8	1	4,1	77138 15	950V2500000E8LE/E3
V250 LE/CU	250	250	81-121	20	8	1	4,1	77138 22	950V2500000E8LE/CU

Cassette cover for screed 250×250 mm, for 8 appliances.
Leveling range: 71-111 mm and 81-121 mm, min. installation depth: 71 mm, or 81 mm.
Available in stainless steel (W. Nr. 1.4301) or brass (CuZn).
For 8 pcs. of MOSAIC 45 appliances.
Primarily for tiles, wood floor.
Load capacity: max. 150 kg



V125 ST

Article	Dimensions (mm)			Floor covering thickness (mm)	Appliances Nr. (pcs)	PU. (pcs)	Wgt. (kg)	EAN	Order number
	W.	L.	H.						
V125 ST LE/E3	125	125	71-111	10	2	1	1,7	77138 39	950V125ST00E2LE/E3
V125 ST LE/CU	125	125	71-111	10	2	1	1,7	77138 46	950V125ST00E2LE/CU

Cassette cover for screed, 125×125 mm, for 2 appliances.
With floor covering protection frame.

Leveling range: 71-111 mm and 81-121 mm, min. installation depth: 71 mm.

Available in stainless steel (W. Nr. 1.4301) or brass (CuZn).

For 2 pcs. of MOSAIC 45 appliances.

Primarily for tiles, wood floor.

Load capacity: max. 150 kg

V200 ST



Article	Dimensions (mm)			Floor covering thickness (mm)	Appliances Nr. (pcs)	PU. (pcs)	Wgt. (kg)	EAN	Order number
	W.	L.	H.						
V200 ST LE/E3	200	200	71-111	10	6	1	3	77138 53	950V200ST00E6LE/E3
V200 ST LE/CU	200	200	71-111	10	6	1	3	77138 60	950V200ST00E6LE/CU

Cassette cover for screed 200×200 mm, for 6 appliances.

With floor covering protection frame.

Leveling range: 71-111 mm and 81-121 mm, min. installation depth: 71 mm.

Available in stainless steel (W. Nr. 1.4301) or brass (CuZn).

For 6 pcs. of MOSAIC 45 appliances.

Primarily for tiles, wood floor.

Load capacity: max. 150 kg

V250 ST



Article	Dimensions (mm)			Floor covering thickness (mm)	Appliances Nr. (pcs)	PU. (pcs)	Wgt. (kg)	EAN	Order number
	W.	L.	H.						
V250 ST LE/E3	250	250	71-111	10	8	1	4	77138 77	950V250ST00E8LE/E3
V250 ST LE/CU	250	250	71-111	10	8	1	4	77138 84	950V250ST00E8LE/CU

Cassette cover for screed 250×250 mm, for 8 appliances.

With floor covering protection frame.

Leveling range: 71-111 mm and 81-121 mm, min. installation depth: 71 mm.

Available in stainless steel (W. Nr. 1.4301) or brass (CuZn).

For 8 pcs. of MOSAIC 45 appliances.

Primarily for tiles, wood floor.

Load capacity: max. 150 kg

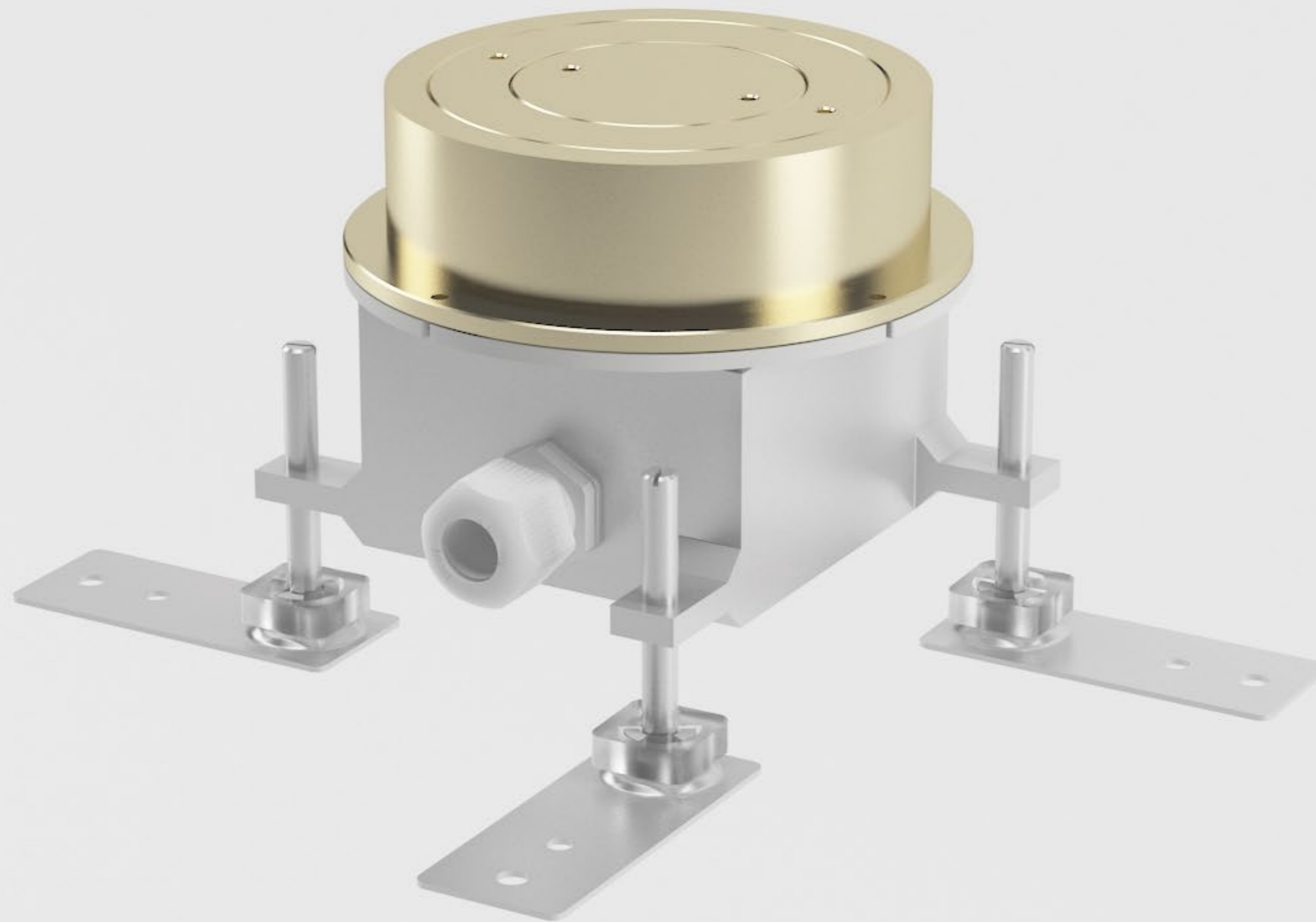

IP-PROTECTED COVERS



/IP-PROTECTED CASSETTE COVERS

Cassette covers	Dimensions (mm)			Min. installation depth (mm)	Number of appliances	
	W.	L.	H.		pcs	type
S010 Q1AK	100	100	84-99	84	1	MOSAIC 45
S120 R1AK	Ø120		84-99	84	1	MOSAIC 45
SV301-4S	Ø280		234		4	Schuko + CEE
2008A	250	250	82		8	Schuko

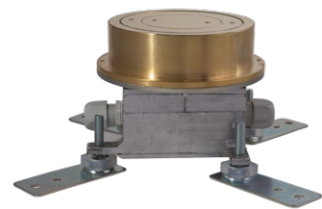

S120

Article	Dimensions (mm)			Module* (pcs)	PU. (pcs)	Wgt. (kg)	EAN	Order number
	W.	L.	H.					
S120 R1AK	Ø120	110-125	3	1	1,64	77072 89		950S120R1AK

IP-protected cassette cover for screed, Ø120 mm, for 1,5 appliances.
Leveling range: 110-125 mm, min. installation depth: 110 mm.
Available in brass (CuZn).
Dust and mist protection with rubber sealing ring and protective cover with cable gland (IP-54).
Shipping: with 1 pc. MOSAIC 45 socket (RAL 9010).



S010

Article	Dimensions (mm)			Module* (pcs)	PU. (pcs)	Wgt. (kg)	EAN	Order number
	W.	L.	H.					
S010 Q1AK	100	100	84-99	2	1	1,64	77020 48	950S010Q1AK

IP-protected cassette cover for screed, 100×100 mm, for 1 appliance.
Leveling range: 84-99 mm, min. installation depth: 84 mm.
Available in brass (CuZn).
Dust and mist protection with rubber sealing ring and protective cover with cable gland (IP-54).
Shipping: with 1 pc. MOSAIC 45 socket (RAL 9010).

IP-PROTECTED CASSETTE COVERS\



Protective cover with cable gland

Article	Dimensions (mm)			PU. (pcs)	Wgt. (kg)	EAN	Order number
	W.	L.	H.				
Protective cover	Ø68	75	1	0,35	77139 90		955S010HARANG0000002

Protective cover with cable gland for S120 and S010 IP-protected cassette covers.
For IP-54-protected cable routing.



SV301-4S

Article	Dimensions (mm)			Appliances Nr.	PU. (pcs)	Wgt. (kg)	Order number
	W.	L.	H.				
Bodensteckdosen SV301-4S	Ø280	234	4	1	9,50		950SV301-4S

Retractable power distributor for outdoor use. The housing is watertight when closed, protection class IP67. Lockable with special key.
Equipped with 3 Schuko socket and 1 CEE 5/16A. Further assembly variants on request.
Maximum load capacity 6,5t.



2008A

Article	Dimensions (mm)			Appliances Nr.	PU. (pcs)	Wgt. (kg)	Order number
	W.	L.	H.				
Bodensteckdosen 2008A	250	250	82	8	1	3,70	9502008A

The housing of the cassette cover made of 1,5 mm thick V2A stainless steel and has a lockable aluminium lid. It is suitable for cleaning with wet sweepers. Protection class IP54.
Equipped with 8 Schuko socket. Further assembly variants on request.
Maximum load capacity 900kg.

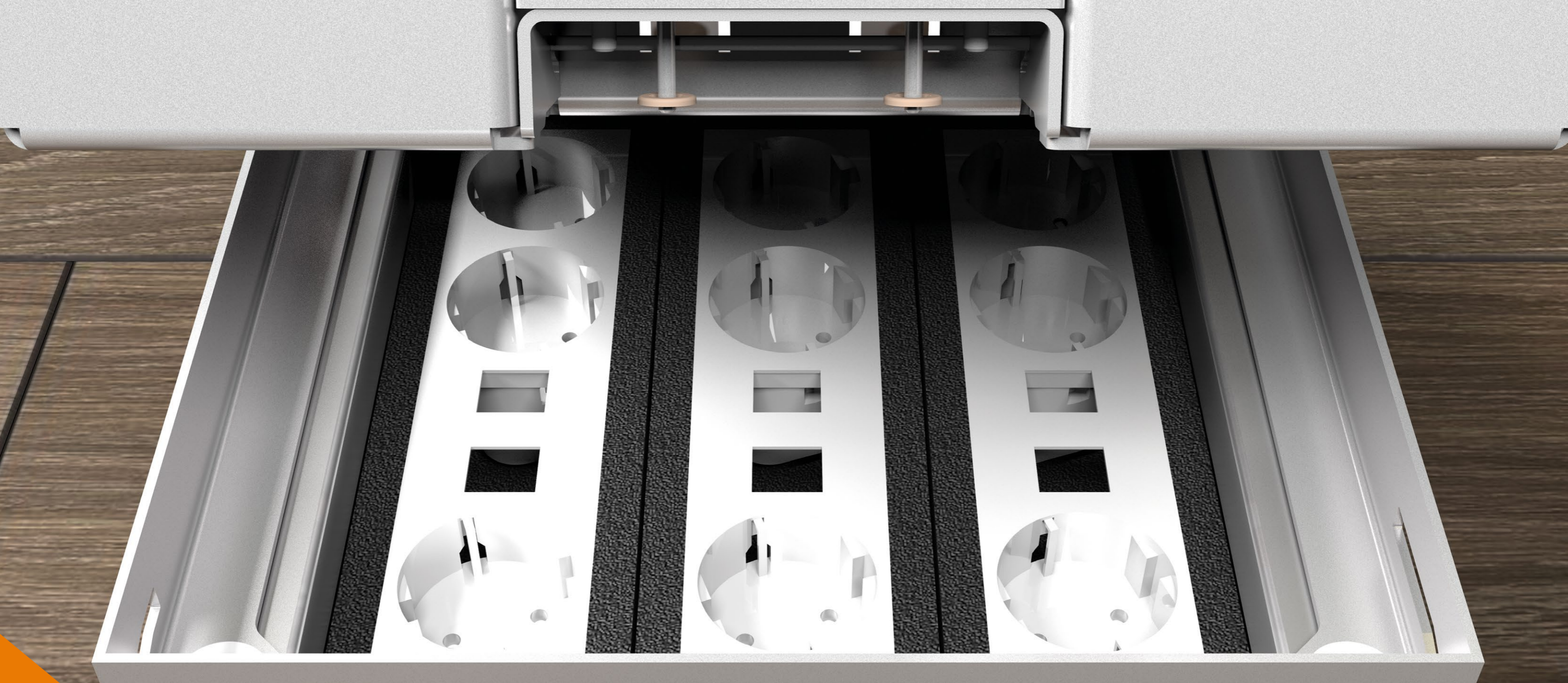

APPLIANCES AND ACCESSORIES



/APPLIANCES AND ACCESSORIES

APPARATUS BOXES



GB3 569 8M complete

Article	Appliances Nr.	PU. (pcs)	Wgt. (kg)	EAN	Order number
GB3 569	4	1	0,09	57010 11	95040570101100000000

Conditioned plastic apparatus box.
For 4 pcs. of MOSAIC 45 appliances.
For C-series, ECO-series, F-series cassette covers and cassettes.
Colour: black

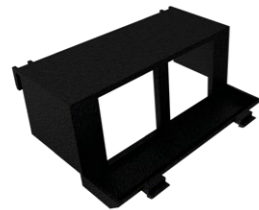

GB4 M4/45

Article	Appliances Nr.	PU. (pcs)	Wgt. (kg)	EAN	Order number
GB4 M4/45	2	1		59970 10	950GB4M4/45.01

Conditioned plastic apparatus box.
For 2 pcs. of MOSAIC 45 appliances.
For KD1 E245 and KD1 E4S plastic covers.
Colour: black



GB4 M6/45

Article	Appliances Nr.	PU. (pcs)	Wgt. (kg)	EAN	Order number
GB4 M6/45	3	1		21189 55	950GB4M6/45.01

Conditioned plastic apparatus box.
For 4 pcs. of MOSAIC 45 appliances.
For KD1 E4S plastic covers.
Colour: black



GB4 M8/45

Article	Appliances Nr.	PU. (pcs)	Wgt. (kg)	EAN	Order number
GB4 M8/45	4	1		30903 89	950GB4M8/45.01

Conditioned plastic apparatus box.
For 4 pcs. of MOSAIC 45 appliances.
For KD1 Q2S plastic covers.
Colour: black

APPLIANCES AND ACCESSORIES\

INNER ACCESSORIES



568-569 inner cover

Article	Cassette cover	PU. (pcs)	Wgt. (kg)	EAN	Order number
568-569	KD1 Q2S	1	0,03	31907 09	950681152045A.02

Conditioned plastic cover for KD1 Q2S plastic covers.
Colour: black

/APPLIANCES AND ACCESSORIES

APPLIANCES



MOSAIC 45 socket

Article	Ext. dim. (mm)		Current rating	PU. (pcs)	Wgt. (kg)	EAN	Order number
	W.	L.					
ISM2 45 9010 QHA	45	45	high	1	0,04	20425 71	950ISM2452--QHA.9010
ISM2 45 9010 QHM	45	45	high	1	0,04	77139 52	950ISM2452--QHM.9010
ISM2 45 2004 QHA	45	45	high	1	0,04	12043 70	950ISM2452--QHA.2004
ISM2 45 2004 QHM	45	45	high	1	0,04	77139 69	950ISM2452--QHM.2004
ISM2 45 6004 QHA	45	45	high	1	0,04	12043 32	950ISM2452--QHA.6004
ISM2 45 6004 QHM	45	45	high	1	0,04	77139 76	950ISM2452--QHM.6004

MOSAIC 45 appliance

Size: 45×45 mm.

Colours: RAL 9010 - pure white, RAL 2004 - pure orange, RAL 6001 - emerald green.

MOSAIC 45 double socket

Article	Ext. dim. (mm)		Current rating	PU. (pcs)	Wgt. (kg)	EAN	Order number
	W.	L.					
ISM4 45 9010 QHA	45	90	high	1	0,08	77139 83	950ISM4452--QHM.9010

White MOSAIC 45 appliance

Size: 45×90 mm.

Colour: RAL 9010 - pure white.



MOSAIC 45 click socket

Article	Ext. dim. (mm)		Current rating	PU. (pcs)	Wgt. (kg)	EAN	Order number
	W.	L.					
ISM2 45 2--QHM 9010 Click	45	45	high	1	0,04	77139 75	950ISM2452--QHM.9010C

MOSAIC 45 click appliance

Size: 45×45 mm.

Colour: RAL 9010 - pure white.



Blind cover

Article	Ext. dim. (mm)		PU. (pcs)	Wgt. (kg)	EAN	Order number
	W.	L.				
IDM2 B/45A	45	45	1	0,01	45140 05	950681152045A.01

White MOSAIC 45 blind cover.

Size: 45×45 mm.

Colour: RAL 9010 - pure white.

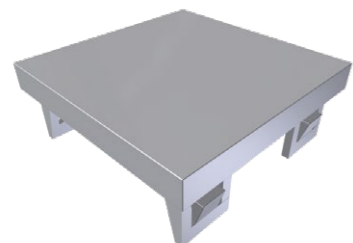

APPLIANCES AND ACCESSORIES\

Data technology support, 1 module

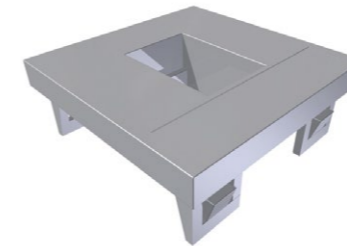

Article	Ext. dim. (mm)		PU. (pcs)	Wgt. (kg)	EAN	Order number
	W.	L.				
IDM2 MWT 1/45A	45	45	1	0,01	45170 05	950681522045.01

White data technology support, MOSAIC 45, for 1 data module.

Size: 45×45 mm.

Colour: RAL 9010 - pure white.

Data transfer and telecommunication support suitable for the following data communication modules:

Rj45 cat 5 utp, Rj45 cat 5 ftp

Rj45 cat 6 utp, Rj45 cat 6 ftp

Data technology support, 2 module

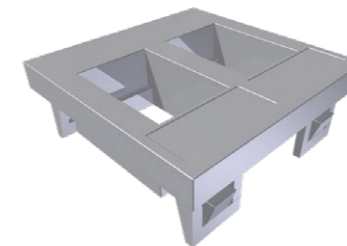

Article	Ext. dim. (mm)		PU. (pcs)	Wgt. (kg)	EAN	Order number
	W.	L.				
IDM2 MWT 2/45A	45	45	1	0,01	45230 05	950681521045A.01

White data technology support, MOSAIC 45, for 2 data module.

Size: 45×45 mm.

Colour: RAL 9010 - pure white.

Data transfer and telecommunication support suitable for the following data communication modules:

Rj45 cat 5 utp, Rj45 cat 5 ftp

Rj45 cat 6 utp, Rj45 cat 6 ftp

/APPLIANCES AND ACCESSORIES

PLASTIC INLAY PLATES

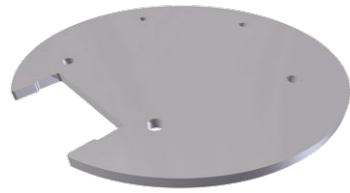

HPVC C305

Article	Dimensions (mm)		Thickness (mm)	PU. (pcs)	EAN	Order number
	W.	L.				
HPVC C305	Ø294		8	1	77121 84	950HPVCC30500001

Inlay plates for C-series cassette covers made of HPVC plastic.
For leveling to the floor.
Thickness: 8 mm
Colour: white

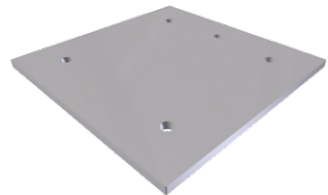

HPVC ECO250 B1

Article	Dimensions (mm)		Thickness (mm)	PU. (pcs)	EAN	Order number
	W.	L.				
HPVC ECO250 B1	239	239	8	1	77122 83	950HPVC250X250V1

Inlay plates for ECO250 blindcassettes without frame made of HPVC plastic.
For leveling to the floor.
Thickness: 8 mm
Colour: white

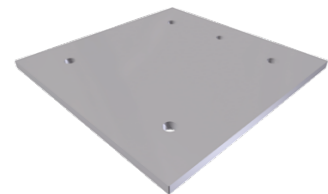

HPVC ECO250 B2

Article	Dimensions (mm)		Thickness (mm)	PU. (pcs)	EAN	Order number
	W.	L.				
HPVC ECO250 B2	235	235	8	1	77122 76	950HPVC250X250V2

Inlay plates for ECO250 blindcassettes with frame made of HPVC plastic.
For leveling to the floor.
Thickness: 8 mm
Colour: white

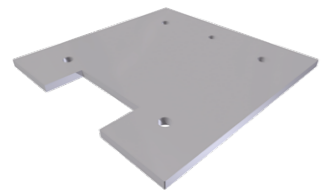

HPVC 250

Article	Dimensions (mm)		Thickness (mm)	PU. (pcs)	EAN	Order number
	W.	L.				
HPVC 250	239	239	8	1	77122 38	950HPVC250X25001

Inlay plates for F250S and V250 Slim and ECO 250 (without frame) cassette covers made of HPVC plastic.
For leveling to the floor.
Thickness: 8 mm
Colour: white

APPLIANCES AND ACCESSORIES\

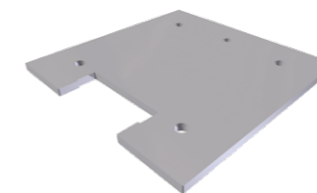

HPVC ECO250 LE

Article	Dimensions (mm)		Thickness (mm)	PU. (pcs)	EAN	Order number
	W.	L.				
HPVC ECO250 LE	235	235	8	1	77122 45	950HPVC250X250P1

Inlay plates for ECO250 cassette covers with frame made of HPVC plastic.
For leveling to the floor.
Thickness: 8 mm
Colour: white

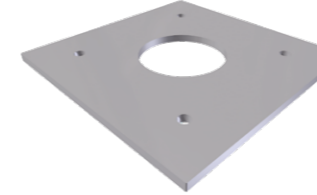

HPVC ECO250 TUM1

Article	Dimensions (mm)		Thickness (mm)	PU. (pcs)	EAN	Order number
	W.	L.				
HPVC ECO250 TUM1	239	239	8	1	77122 69	950HPVC250X250T1

Inlay plates for ECO250 cassette covers without frame, with tube cable outlet made of HPVC plastic.
For leveling to the floor.
Thickness: 8 mm
Colour: white

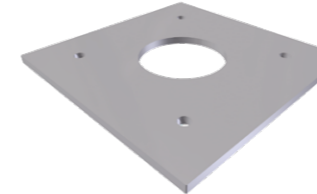

HPVC ECO250 TUM2

Article	Dimensions (mm)		Thickness (mm)	PU. (pcs)	EAN	Order number
	W.	L.				
HPVC ECO250 TUM2	235	235	8	1	77122 52	950HPVC250X250T2

Inlay plates for ECO250 cassette covers with frame and tube cable outlet made of HPVC plastic.
For leveling to the floor.
Thickness: 8 mm
Colour: white

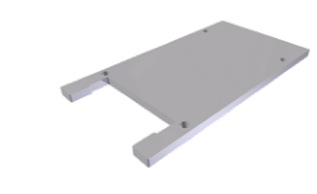

HPVC F140

Article	Dimensions (mm)		Thickness (mm)	PU. (pcs)	EAN	Order number
	W.	L.				
HPVC F140	129	239	8	1	77122 07	950HPVC140X25001

Inlay plates for F140S cassette covers made of HPVC plastic.
For leveling to the floor.
Thickness: 8 mm
Colour: white

/APPLIANCES AND ACCESSORIES

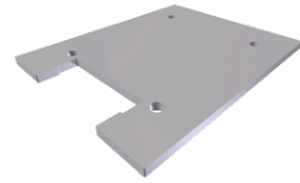

HPVC F200

Article	Dimensions (mm)		Thickness (mm)	PU. (pcs)	EAN	Order number
	W.	L.				
HPVC F200	189	239	8	1	77122 21	950HPVC200X25001

Inlay plates for F200S cassette covers made of HPVC plastic.
For leveling to the floor.
Thickness: 8 mm
Colour: white

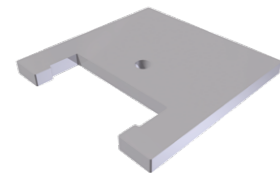

HPVC V125

Article	Dimensions (mm)		Thickness (mm)	PU. (pcs)	EAN	Order number
	W.	L.				
HPVC V125	114	114	8	1	77121 91	950HPVC125X12501

Inlay plates for V125 Slim cassette covers made of HPVC plastic.
For leveling to the floor.
Thickness: 8 mm
Colour: white

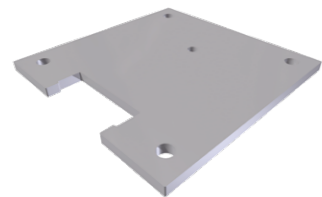

HPVC V200

Article	Dimensions (mm)		Thickness (mm)	PU. (pcs)	EAN	Order number
	W.	L.				
HPVC V200	189	189	8	1	77122 14	950HPVC200X20001

Inlay plates for V200 Slim cassette covers made of HPVC plastic.
For leveling to the floor.
Thickness: 8 mm
Colour: white

APPLIANCES AND ACCESSORIES\

STEEL INLAY PLATES

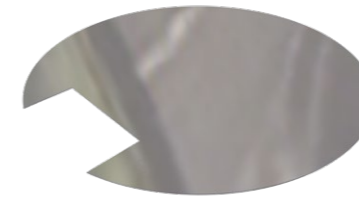

C305 Rm

Article	Dimensions (mm)		Thickness (mm)	PU. (pcs)	Wgt. (kg)	EAN	Order number
	W.	L.					
C305 Rm	Ø294		2	1	1,06	77123 99	950BL3050000RM01

Inlay plates for C-series cassette covers, made of brushed stainless steel.
For leveling to the floor.
Thickness: 2 mm

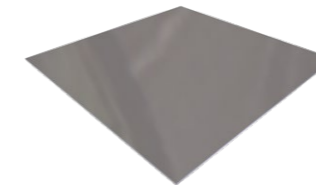

ECO250 B1 Rm

Article	Dimensions (mm)		Thickness (mm)	PU. (pcs)	Wgt. (kg)	EAN	Order number
	W.	L.					
ECO250 B1 Rm	239	239	2	1	0,86	77123 75	950BL250X250RMV1

Inlay plates for ECO250 blind cassettes without frame made of brushed stainless steel.
For leveling to the floor.
Thickness: 2 mm

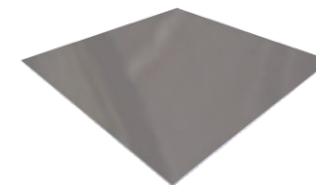

ECO250 B2 Rm

Article	Dimensions (mm)		Thickness (mm)	PU. (pcs)	Wgt. (kg)	EAN	Order number
	W.	L.					
ECO250 B2 Rm	235	235	2	1	0,91	77123 82	950BL250X250RMV2

Inlay plates for ECO250 blind cassettes with frame, made of brushed stainless steel.
For leveling to the floor.
Thickness: 2 mm

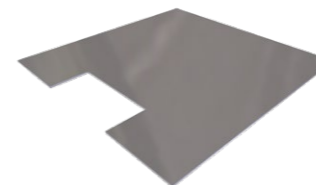

250 Rm

Article	Dimensions (mm)		Thickness (mm)	PU. (pcs)	Wgt. (kg)	EAN	Order number
	W.	L.					
250 Rm	239	239	2	1	0,86	77123 37	950BL250X250RM01

Inlay plates for F250S and V250 Slim and ECO 250 (without frame) cassette covers.
For ECO250 cassette covers.
For leveling to the floor.
Thickness: 2 mm

/APPLIANCES AND ACCESSORIES

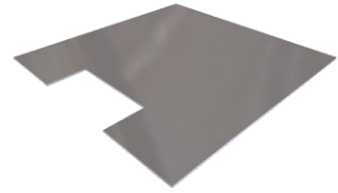

ECO250 LE Rm

Article	Dimensions (mm)		Thickness (mm)	PU. (pcs)	Wgt. (kg)	EAN	Order number
	W.	L.					
ECO250 LE Rm	235	235	2	1	0,81	77123 44	950BL250X250RMP1

Inlay plates for ECO250 cassette covers with frame, made of brushed stainless steel. For leveling to the floor.
Thickness: 2 mm

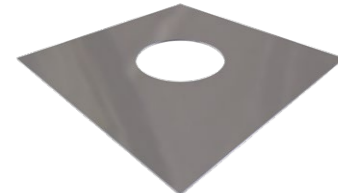

ECO250 TUM1 Rm

Article	Dimensions (mm)		Thickness (mm)	PU. (pcs)	Wgt. (kg)	EAN	Order number
	W.	L.					
ECO250 TUM1 Rm	239	239	2	1	0,80	77126 68	950BL250X250RMT1

Inlay plates for ECO250 cassette covers without frame, with tube, made of brushed stainless steel. For leveling to the floor.
Thickness: 2 mm

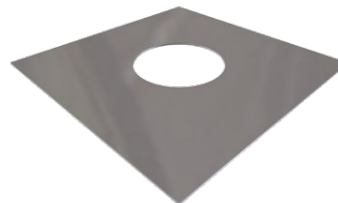

ECO250 TUM2 Rm

Article	Dimensions (mm)		Thickness (mm)	PU. (pcs)	Wgt. (kg)	EAN	Order number
	W.	L.					
ECO250 TUM2 Rm	235	235	2	1	0,75	77123 51	950BL250X250RMT2

Inlay plates for ECO250 cassette covers with frame and tube, made of brushed stainless steel. For leveling to the floor.
Thickness: 2 mm

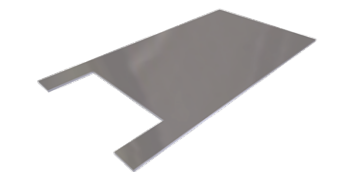

F140 Rm

Article	Dimensions (mm)		Thickness (mm)	PU. (pcs)	Wgt. (kg)	EAN	Order number
	W.	L.					
F140 Rm	129	239	2	1	0,43	77123 06	950BL140X250RM01

Inlay plates for F140S cassette covers made of brushed stainless steel. For leveling to the floor.
Thickness: 2 mm

APPLIANCES AND ACCESSORIES\

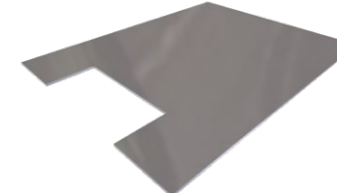

F200 Rm

Article	Dimensions (mm)		Thickness (mm)	PU. (pcs)	Wgt. (kg)	EAN	Order number
	W.	L.					
F200 Rm	189	239	2	1	0,66	77123 20	950BL200X250RM01

Inlay plates for F200S cassette covers made of brushed stainless steel. For leveling to the floor.
Thickness: 2 mm

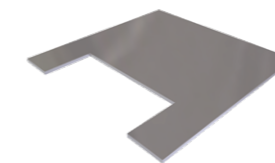

V125 Rm

Article	Dimensions (mm)		Thickness (mm)	PU. (pcs)	Wgt. (kg)	EAN	Order number
	W.	L.					
V125 Rm	114	114	2	1	0,17	77122 90	950BL125X125RM01

Inlay plates for V125 Slim cassette covers made of brushed stainless steel. For leveling to the floor.
Thickness: 2 mm

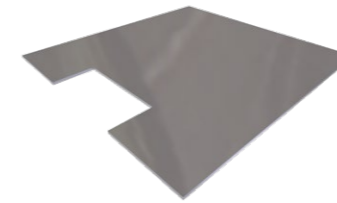

V200 Rm

Article	Dimensions (mm)		Thickness (mm)	PU. (pcs)	Wgt. (kg)	EAN	Order number
	W.	L.					
V200 Rm	189	189	2	1	0,53	77123 13	950BL200X200RM01

Inlay plates for V200 Slim cassette covers made of brushed stainless steel. For leveling to the floor.
Thickness: 2 mm

/APPLIANCES AND ACCESSORIES

TUBE, TUBE CABLE OUTLET



Tube

Article	PU. (pcs)	EAN	Order number
Tube	1	18104 40	950tubus

Tube for tube cable outlet.
Nickel-plated.
For 23 mm flooring.



Tube cable outlet

Article	PU. (pcs)	EAN	Order number
Tube cable outlet	1	18104 43	950tubuskivezető

Tube cable outlet for tube. In use it stands out from the floor.
With sealing.
Nickel-plated.



Tube-opener

Article	PU. (pcs)	EAN	Order number
Tube-opener	1	77125 35	950tubusnyitó

Tool for open the tube.
Easy to use
Stainless steel.



APPLIANCES AND ACCESSORIES\

FIXING BRACKETS

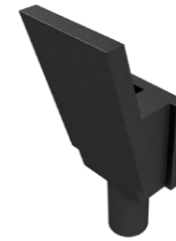

ZEO B1

Article	Clamping range	PU. (pcs)	Wgt. (kg)	EAN	Order number
ZEO B1	Up to 27 mm	1	0,04	20222 21	950ZE0B100000000001

Fixing bracket.
For C- and ECO-series cassette covers.
The clamping range of the C-cassette covers: 2-16 mm.
The clamping range of the ECO-cassette covers: 13-27 mm.



ZEO B2

Article	Clamping range	PU. (pcs)	Wgt. (kg)	EAN	Order number
ZEO B2	Up to 44 mm	1	0,04	20222 38	95035203201000000001

Fixing bracket for cavity floor.
For C- and ECO-series cassette covers.
The clamping range of the C-cassette covers for cavity floor: 17-33 mm.
The clamping range of the ECO-cassette covers for cavity floor:

- In case of 10 mm flooring recess: 18-34 mm,
- In case of 20 mm flooring recess: 28-44 mm.



ZEO B3

Article	Clamping range	PU. (pcs)	Wgt. (kg)	EAN	Order number
ZEO B3	Up to 60 mm	1	0,04	20330 10	95035203301000000001

Fixing bracket for cavity floor.
For C- and ECO-series cassette covers.
The clamping range of the C-cassette covers for cavity floor: 34-49 mm.
The clamping range of the ECO-cassette covers for cavity floor:

- In case of 10 mm flooring recess: 35-50 mm,
- In case of 20 mm flooring recess: 45-60 mm.

/APPLIANCES AND ACCESSORIES

HEIGHT EXTENSION



HW HEIGHT EXTENSION

Article	Dimensions (mm)			Leveling range	Cassette cover	PU. (pcs)	Wgt. (kg)	EAN	Order number
	W.	L.	H.						
HW Q200 20-70	250	200	80	20-70	V125, V200	1	1,6	77138 91	950HW200x200EM2070
HW Q200 100-150	250	200	160	100-150	V125, V200	1	1,7	77139 07	950HW200x200EM1015
HW Q250 20-70	300	250	80	20-70	F200, F250, ECO250	1	2,3	77139 14	950HW250x250EM2070
HW Q250 100-150	300	250	160	100-150	F200, F250, ECO250	1	2,4	77139 21	950HW250x250EM1015
HW Q300 20-70	350	300	80	20-70	C305	1	3,1	77139 38	950HW300x300EM2070
HW Q300 100-150	350	300	160	100-150	C305	1	3,2	77139 45	950HW300x300EM1015

Height extension for C-, ECO cassette covers with adjustable leveling units, and also for F- and V-series cassette covers.

/REFERENCES*

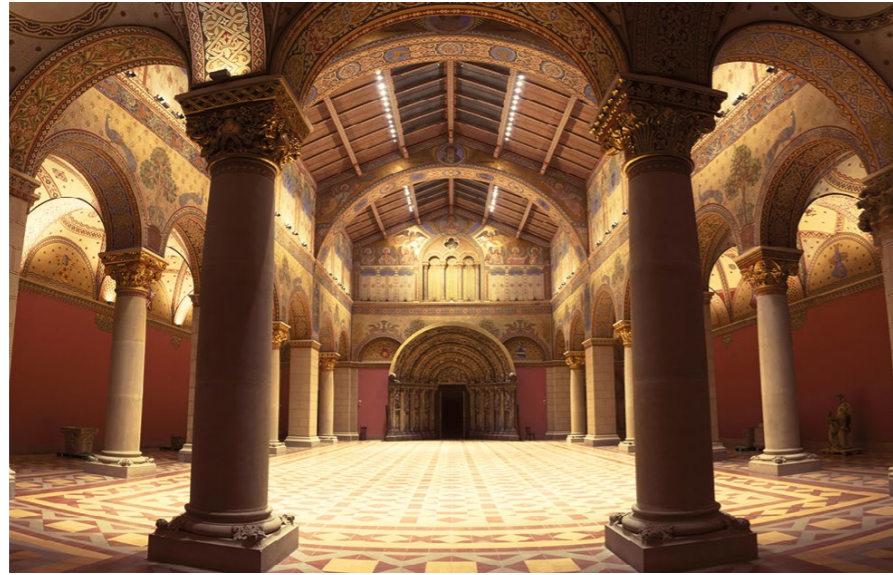

The Romanesque Hall, Museum of Fine Arts, Budapest, @szepmuneszeti.hu



Hilton Budapest, Castle Quarter @ceglass.eu



Radisson Blu Carlton, Bratislava, @travelguide.sk

*REFERENCES\



Puskás Aréna, @168.hu



MOMÉ 3. Campus, @mome.hu



Corvin 5-6 office building, @welovebudapest.com

*but not exhaustive

/REFERENCES*



MOL CAMPUS, Budapest



Matild Palace, Budapest



Atrium Park, Budapest, @ujiroda.hu

*REFERENCES\



Aston Martin, Budapest



Porsche Centrum, Budapest



National Athletics Centre, Budapest, @magyarepito.hu

*but not exhaustive

CERTIFICATES



ISO 9001:2015 certificate



MSZ EN ISO 14001:2015;
MSZ ISO 45001:2018; MSZ EN ISO 5001:2019

ELECTRAPLAN

www.electraplan.hu

Your trading partner:



Electraplan-Termelő Kft.
2030 Érd, Budafoki street 10.
Hungary
Tel: +36 23 521 300
info@electraplan.hu
www.padlodoz.hu
www.electraplan.hu

Cassette cover
installation
demonstration video

